



COLLABAT

WEBINAR

LIFE CYCLE ASSESSMENT

The Priceless Value of LCA in the Circular Economy and its Influence in the Battery Industry

5
DEC

From 9:00 to 11:00 CET



REGISTER NOW

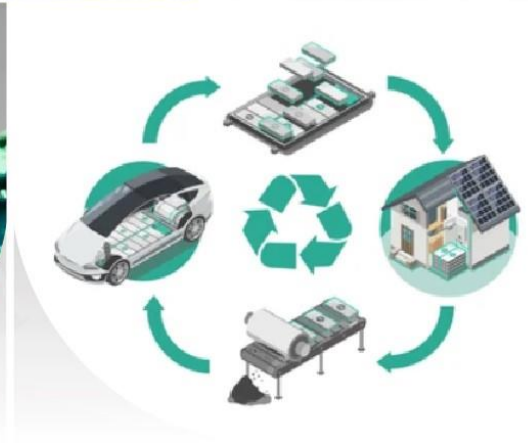

We integrate the principles of Life Cycle Assessment (LCA) and Circular Economy to help redefine the future of electric vehicle (EV) batteries



- 9:10
- ❑ Our expert-led session, "LCA & Circular Economy for Optimal Management of EV Batteries," will illuminate the path to a more sustainable, circular transition in electromobility.
 - ❑ In the segment "Navigating the Sustainable Landscape of the Battery Pack through LCA," we will highlight the importance of eco-design and sustainable practices from the beginning to the end of a battery's life cycle.
 - ❑ Furthermore, we will give an overview of strategies to minimize environmental impacts through new recyclability treatments to integrate them in battery LCA models in the section titled "Powering Up Recycling in LCA and its Impact on the Battery Industry."
 - ❑ Lastly, we will examine the Life Cycle Analysis of Advanced Lightweight Battery Systems for Electric Vehicles, focusing on how these innovations align with European battery waste regulations and contribute to resource efficiency.

09:50	Q&A for all speakers
10:00	PANEL DISCUSSION: "Common points between the different projects and lessons learned"
10:30	Q&A
10:50	Wrap-up
11:00	Adjourn

COLLABAT– LCA & Circular Economy for the optimal management of EV batteries. Implications of regulation.

December 5th, 2023

Mondragon Goi Eskola Politeknikoa (MGEP)



Lightweight Battery System for Extended Range at Improved Safety



*LIBERTY has received funding from the European Union's Horizon 2020 research and innovation programme under grant agreement No 963522.
The document reflects only the author's view, the Agency is not responsible for any use that may be made of the information it contains.*

Presenter

Aitor Picatoste
(apicatoste@mondragon.edu)

*Faculty of Engineering,
Mondragon Unibertsitatea*

- PhD thesis on: Circular economy and LCA of batteries for Electric Vehicles



Circular Economy and Industrial Sustainability group (CEIS) → [e-Link](#)

Research, Teaching and Upskilling



Goi Eskola
Politeknikoa
Faculty of
Engineering

Circular Economy
and Industrial
Sustainability (CEIS)

Eco-design
& Life Cycle
Management

Design of
materials,
products &
technologies

Eco-productivity &
Remanufacturing

Efficient and
clean industrial
production
systems

Circular &
Sustainable

New
technology-
enabled
industrial
business
models

Tools &
Indicators

New value
chains and
innovation
systems

Industrial Services and Consultancy

EU regulation on EV batteries

Electric vehicle battery → means a battery that is specifically designed to provide electric power for traction in hybrid or electric vehicles of category L as provided for in Regulation (EU) No 168/2013, that weighs more than 25 kg, or M, N or O as provided for in Regulation (EU) 2018/858 (Article 3, definitions)

Category L	Mopeds or motorcycles
Category M	Passenger vehicles (private or commercial): Cars, buses
Category N	Transport (private or commercial): Vans, trucks
Category O	Freight transport: Trailers

→ European Commission. (2023). **REGULATION (EU) 2023/1542 OF THE EUROPEAN PARLIAMENT AND OF THE COUNCIL of 12 July 2023 concerning batteries and waste batteries**, amending Directive 2008/98/EC and Regulation (EU) 2019/1020 and repealing Directive 2006/66/EC.
https://environment.ec.europa.eu/topics/waste-and-recycling/batteries_en



LCA of battery pack in LIBERTY project

- LIBERTY project → libertyproject.eu/
- Battery sustainability improvement is one of the five objectives of LIBERTY, together with range, charging time, total mileage and safety improvements
- **LIBERTY battery pack vs benchmark battery** will be compared to determine resource and environmental gains.
- Goal of the project: **at least 20% improvement in life cycle environmental impacts**



Life cycle management choices for EV batteries

- There is a knowledge gap regarding the combined LCA and circularity performance of different LCM scenarios
- The LCA and circularity performance of a **nickel cobalt manganese (NMC) battery for EV** considering:
 - **Three second life scenarios:**
 - i) Reuse in another EV
 - ii) Repurposing as a stationary energy storage system (SESS) at a detached house
 - iii) No-second life
 - **Two recycling scenarios:**
 - i) Pyrometallurgy
 - ii) Hydrometallurgy

Perspective of 2nd life options

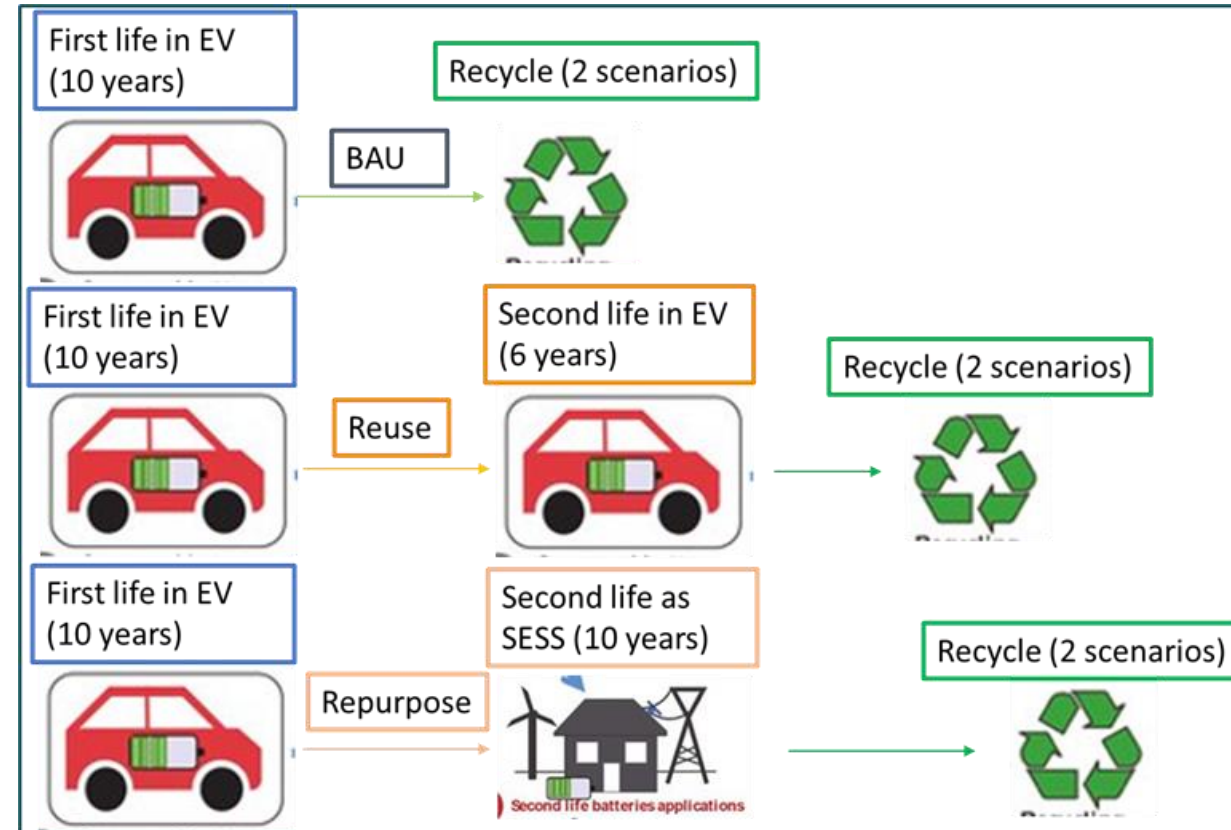

Benchmark battery vs. LIBERTY battery

■ The **baseline battery** for this study is defined as:

- NMC battery of 77kWh capacity and 725kg
- 400km of autonomy, 160,000km of lifetime
- Based on Ellingsen et al. (2014), pyrometallurgy recycling

■ The **LIBERTY battery**:

- NMC battery of 88kWh and 615 kg.
- 500km autonomy, 300,000km of lifetime
- Utilising primary data from the project

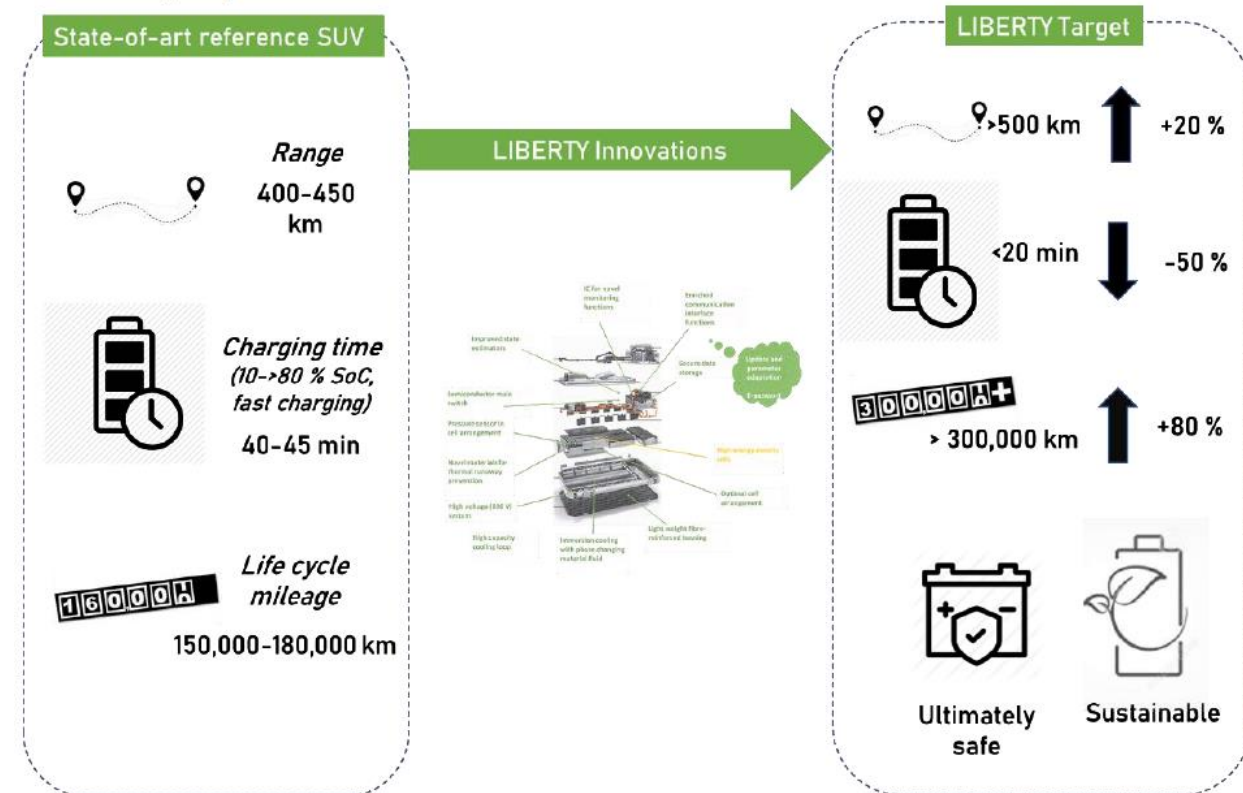

Definition of second life scenarios

■ Reuse scenario:

- 2nd life → installed in an EV for 6 years
- Minimal operation required for reusing in an EV
- Avoided burden of manufacturing and 6 years of use of a new NMC battery
- Adapted from Wewer et al. (2021) and Schulz-Mönninghof et al. (2021)

■ Repurpose scenario:

- 2nd life → Installed in a standalone house as SESS for photovoltaic energy
- Checking and replacement of part of the battery
- Avoided burden of manufacturing a battery with similar characteristics
- Adapted from Schulz-Mönninghof et al. (2021)

Processes/ materials	Description	Input	Unit
Avoided production of a new LIB	Avoided production of the same LIB type	1	kg
Electricity	Initial diagnosis of battery	0.00455	kWh
Battery cell	10% of battery cells replaced	0.012	kg
Battery housing	3% of all battery housing damaged	0.0096	kg
Plug	Replacement of connector	0.0004	kg
BMB/CSE	1 or 2 BMB/CSE replacement	0.00033	kg
Electricity	Electricity for welding: 2 cells, 0.2 sec pr cell, 250 Ws = 0.028 Wh	0.028	Wh
Electricity	End-of-Line test/balancing (0.5 pr battery/110 kg)	0.00455	kWh

Repurposing inventory: Adapted from Schulz-Mönninghof et al. (2021)

Definition of recycling scenarios

- Cell recycling processes are different while the rest of component materials (Al, steel, plastics, copper...) undergo standard recycling process
- **Pyrometallurgy** scenario:
 - Energy consumption: 0.8 kWh/kg
 - Material recovery after refining:
 - Aluminium and copper > 93%
 - Co, Ni and Mg sulphates: 84%
- **Hydrometallurgy** scenario:
 - Energy consumption: 0.14 kWh/kg
 - Material recovery after refining:
 - Lithium, aluminium and copper > 90%
 - Co, Ni and Mg sulphates: 84%

INPUTS		
Waste battery cells	1	kg
NaOH	0.21	kg
Electricity	0.8	kWh
Water	1	l
Infrastructure	5E-10	Items
OUTPUTS		
Al+Cu to refining	0.27	kg
Aluminum	0.053	kg
Copper	0.21	kg
Cobalt compound (CoSO ₄)	0.17	kg
Nickel compound (NiSO ₄)	0.17	kg
Manganese compound (MnSO ₄)	0.16	kg

Inventory for Pyrometallurgy recycling. Adapted from Mohr et al. (2020)

Selected methods for LCA and Circularity calculations

- The functional unit selected for the LCA calculations was: 1 kWh of energy delivered by the battery
- Credits are provided with the **avoided burden** method
- Representative categories for environmental impact savings calculations:
 - **Global warming potential** (GWP) (kg CO₂ eq.)
 - **Abiotic depletion potential of minerals** (ADP-m) (kg Sb eq.)
 - Calculation method CML (2016) based on the recommendations from the PEFCR (EC, 2018)
- For the circularity calculations, the **Product Circularity Indicator** (PCI) (Bracquené et al., 2020) was selected:
 - Quantitative single digit indicator ranging between 0 (linear product) and 1 (fully circular)
 - Considers multiple material circulation aspects as well as the longevity of the product

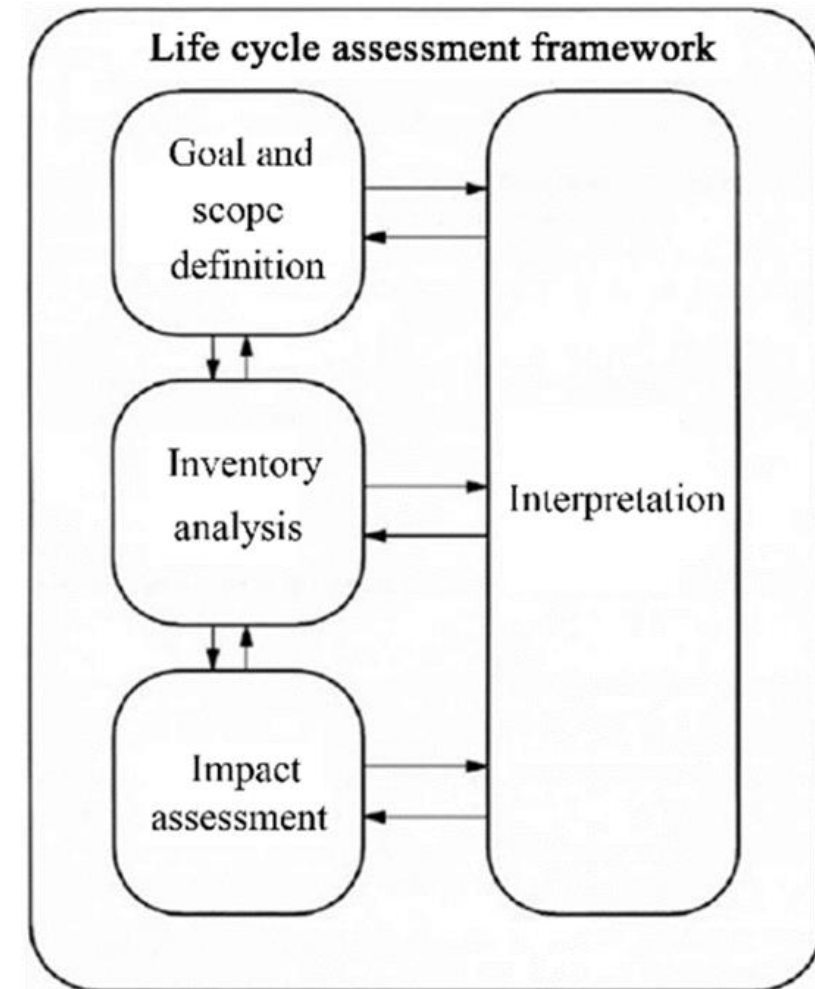

Results for second life and recycling savings

- Improvements lie in the 13%-20% range for PCI, 10%-53% range for GWP, 23%-60% range for ADP-m
- The main **key differences lie on the longevity** and the LCM scenarios. In 2nd life scenarios, apart from the extra lifetime, the **avoided burden of a new battery** manufacturing generates a lot of savings. Specially for **the repurposing scenario, using green energy** to charge the battery also improves the GWP savings noticeably.

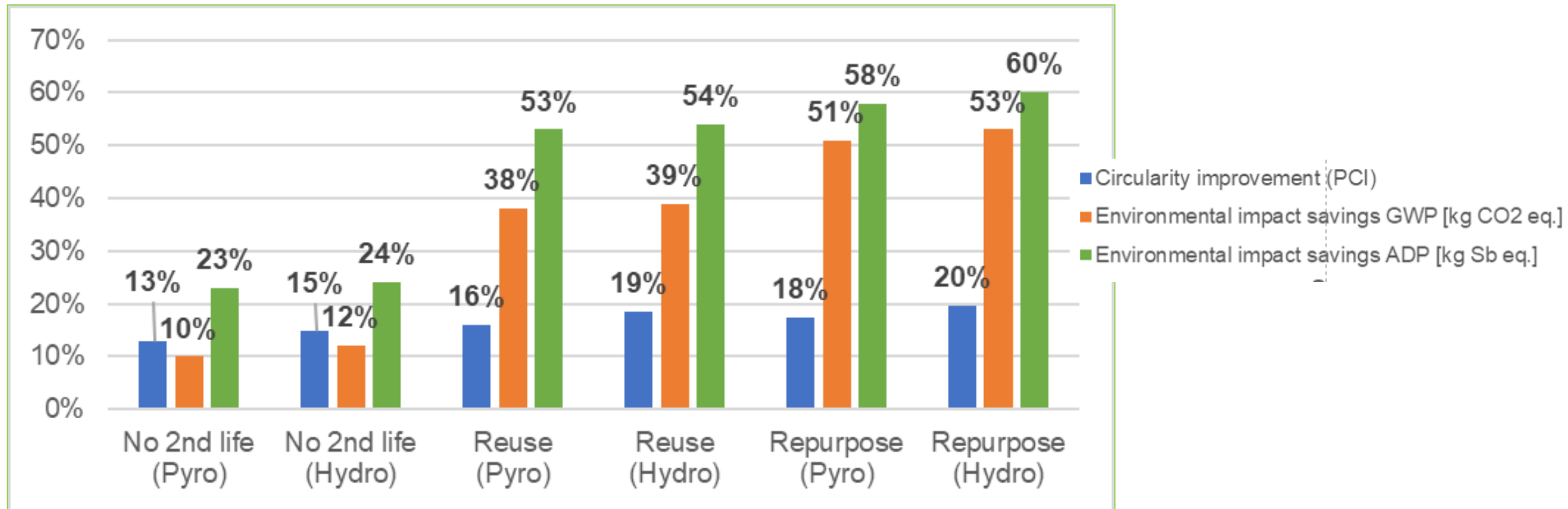

Adequate metrics for EV battery environmental results

- The circularity indicators severely undermine the importance of longevity as seen in previous discussions.
- This calculation represents the **circularity improvement and environmental savings of repurposing for NMC battery, calculated for different CE indicators**
- The indicator mostly focused on the longevity (Figge et al. 2018) is the most accurate representation of the environmental savings
- REAPro (Ardente & Matheux, 2014) and PCI (Bracquené et al. 2020) could not be useful when measuring the best CE strategies

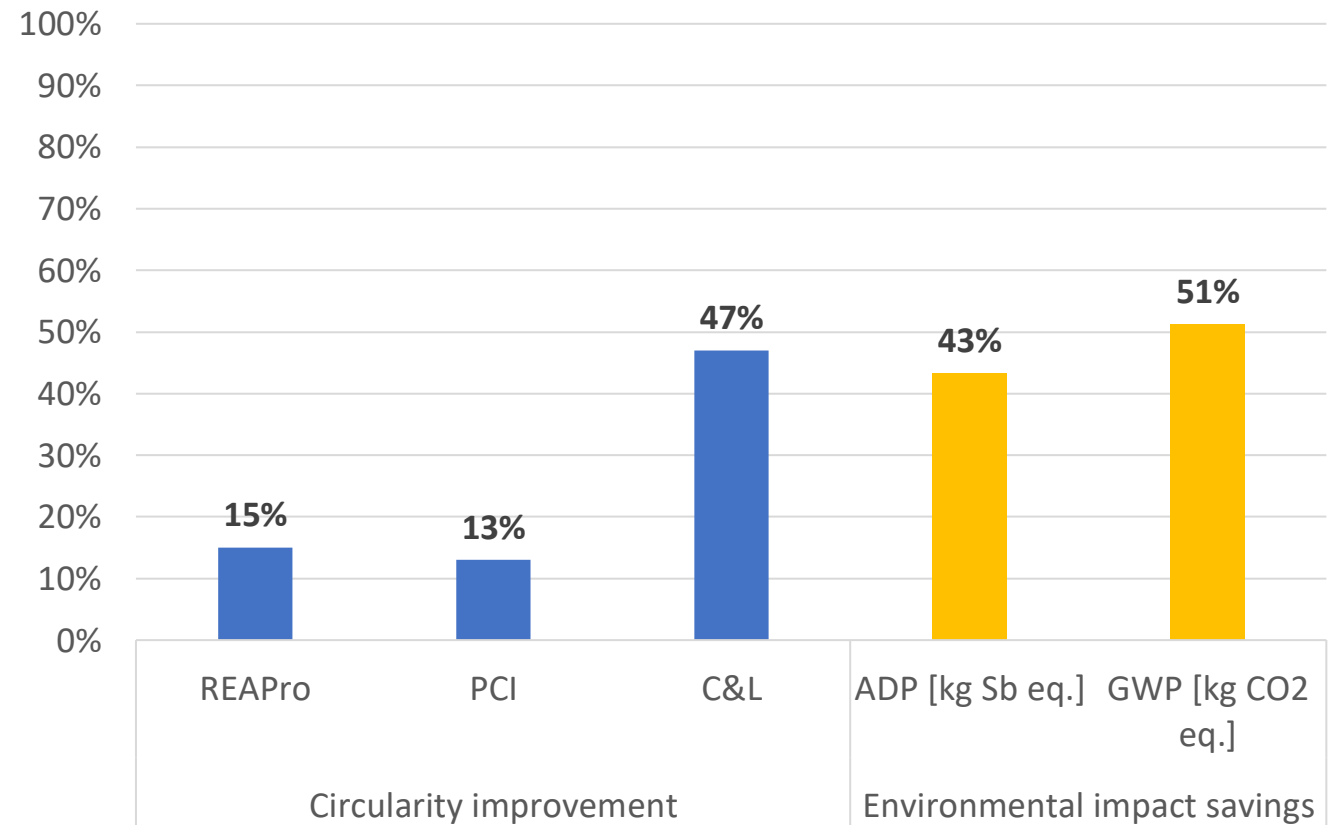

How does EU regulation respond to these issues?

IDENTIFIED ISSUES for LCA practitioners and EU regulation

- EU legislation needs to focus on the **best environmental solutions for EV batteries**
- Important **definitions, metrics and achievable targets are key to push the technology** in the right direction (recycled material, recycling minimums, second life regulations)
- New business models may generate from such an evolving sector as EV batteries. These **definitions ought to help the new businesses establish their activity** according to the best environmental performance possible
- When calculating the environmental impacts of EV batteries, the **allocation methods for the environmental credits (weight, price, cost of recycling process...) must be defined**. 100% of the batteries will undergo a recycling process, practitioners must have a standard to fall to when assigning impacts/credits.

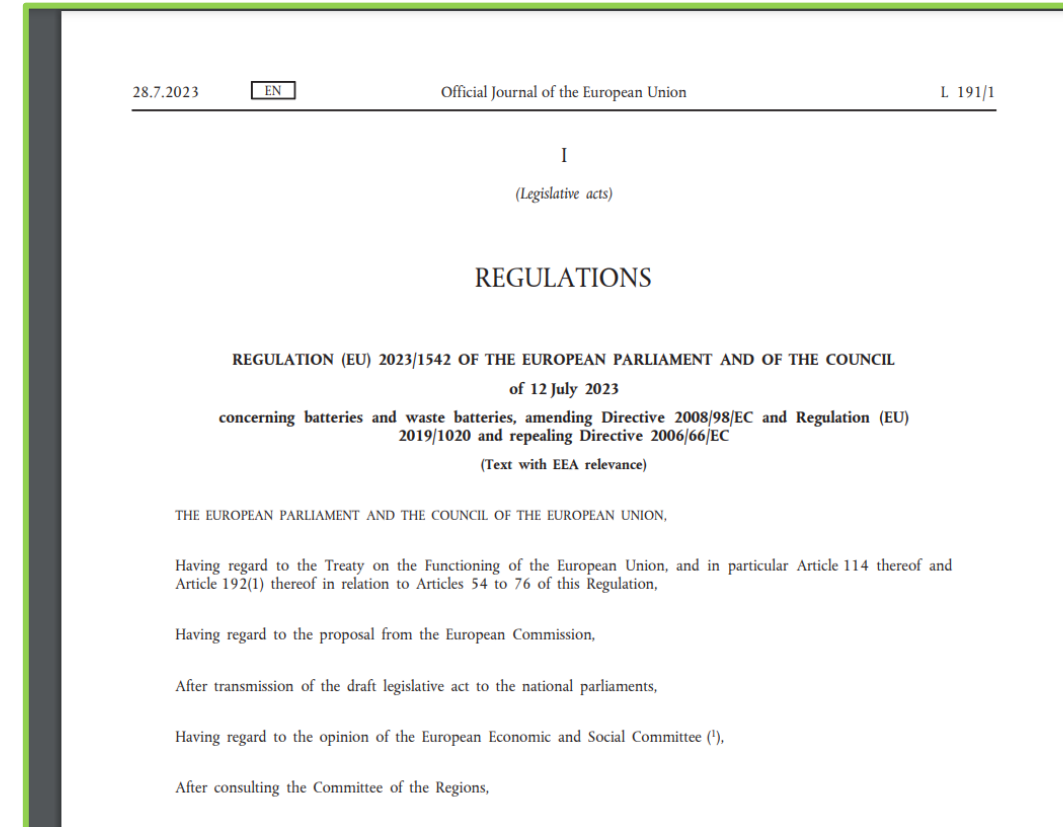

How does EU regulation respond to these issues?

Issue / strategy	EU regulation: REGULATION (EU) 2023/1542 concerning batteries and waste batteries
Reduce Raw Material impact	<ul style="list-style-type: none"> Article 8: Recycled content minimums in 2036: 26 % cobalt; 12 % lithium; 15 % nickel
Recycling targets	<ul style="list-style-type: none"> Annex XII: recycling of 70 % by average weight of lithium-based batteries by 2031 (all materials). For specific materials, recycle 95 % cobalt; 95 % of copper; 80 % of lithium and 95 % for nickel by year 2032
Information availability	<ul style="list-style-type: none"> Annex XIII and Article 78: All the information to be included on the battery passport must be available
Battery ownership and waste hierarchy	<ul style="list-style-type: none"> Waste hierarchy as established by Directive 2008/98/EC which prioritises prevention, preparation for re-use and recycling Any operator that places on the market products incorporating batteries has the extended producer responsibility, not the ownership
How to push for 2nd life?	<ul style="list-style-type: none"> Operators that carry out preparation for re-use, preparation for repurposing, repurposing or remanufacturing, and place on the market or put into service a battery that has undergone any of those operations, shall be considered to be manufacturers for the purposes of this Regulation. Re-use, remanufacture and repurpose considered and defined. Refurbishment is not defined. Better definitions and/or regulations for 2nd life are necessary if the legislation is aiming to push for it
LCA impacts calculation	<ul style="list-style-type: none"> The functional unit is defined as one kWh (kilowatt-hour) of the total energy provided by the battery system over the battery's service life, measured in kWh. The total energy is obtained from the number of cycles multiplied by the amount of delivered energy over each cycle Only carbon footprint is considered when evaluating the environmental impacts of EV batteries, leaving out key categories e.g. material related impacts The carbon footprint of the battery shall be calculated using the 'climate change' life cycle impact assessment method recommended in the 2019 Joint Research Centre report entitled 'Suggestions for updating the Product Environmental Footprint (PEF) method'.
Problems with allocation rules	<ul style="list-style-type: none"> EU has not defined adequate and sector-specific allocation/ credit rules for EV batteries. Multiple stakeholders for batteries have expressed concern on the different results obtained by allocation choices, even pushing for "ineffective" EOL management.
Longevity metrics – pushing for longevity	<ul style="list-style-type: none"> Metrics to identify the remaining lifetime are defined, and made mandatory but not minimums for lifetime or second life stated This does not set any goals in terms of longevity of the batteries

European Commission. (2023). *REGULATION (EU) 2023/1542 OF THE EUROPEAN PARLIAMENT AND OF THE COUNCIL of 12 July 2023 concerning batteries and waste batteries, amending Directive 2008/98/EC and Regulation (EU) 2019/1020 and repealing Directive 2006/66/EC.*
https://environment.ec.europa.eu/topics/waste-and-recycling/batteries_en

Questions / discussion

apicatoste@mondragon.edu, jmfernandez@mondragon.edu

www.libertyproject.eu



Lightweight Battery System for Extended Range at Improved Safety



*LIBERTY has received funding from the European Union's Horizon 2020 research and innovation programme under grant agreement No 963522.
The document reflects only the author's view, the Agency is not responsible for any use that may be made of the information it contains.*



Manufacturing and assembly of modular and reusable EV battery for environment-friendly and lightweight mobility

Navigating the sustainable landscape of the Battery Pack through LCA

PRESENTER NAME: Violeta Vargas (EURECAT)

EMAIL: violeta.vargas@eurecat.org

DATE: December 5th, 2023



Greenhouse gas emissions by the economy and GDP, EU, Q4 2019 - Q4 2022

(million tonnes of CO₂ equivalents, chain linked volumes (2015) million €)

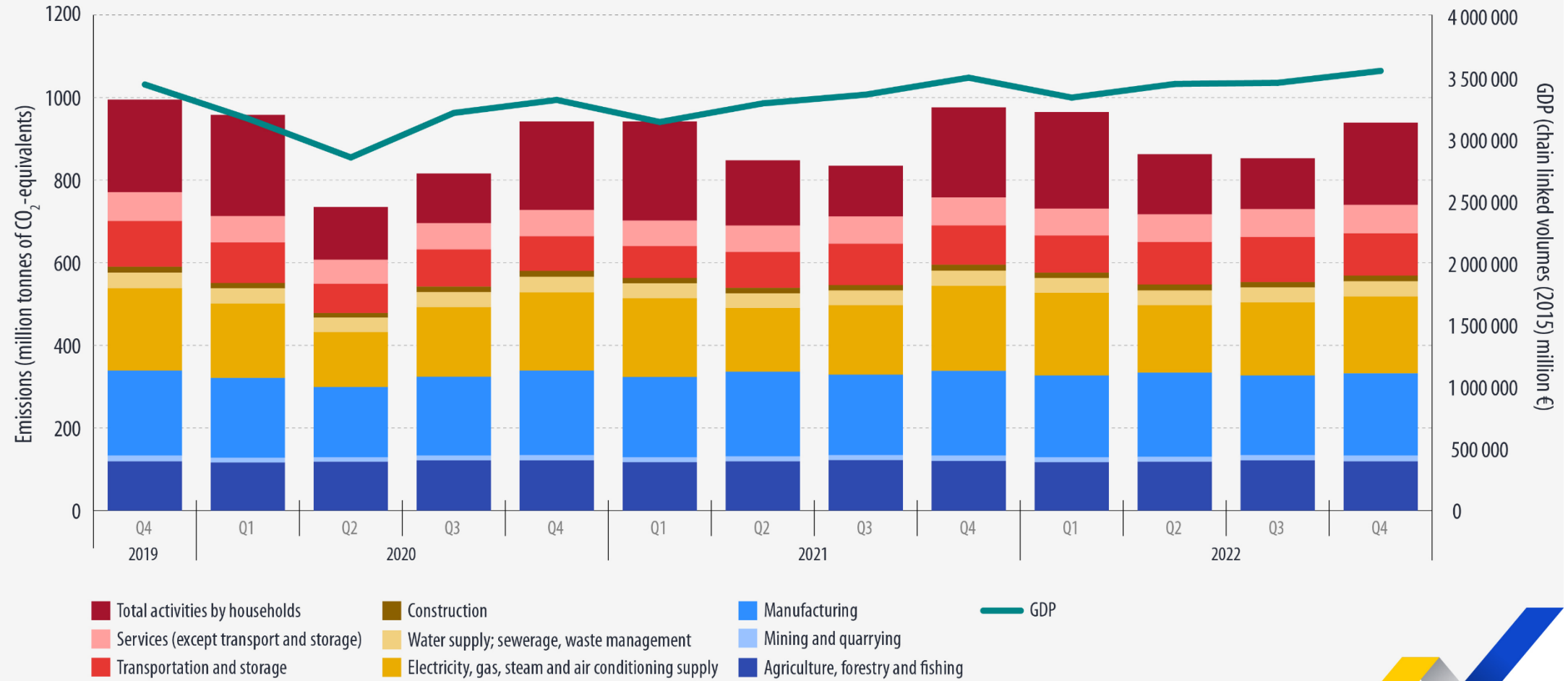

eurostat



Greenhouse gas emissions by the economy and GDP, EU, Q4 2019 - Q4 2022

(million tonnes of CO₂ equivalents, chain linked volumes (2015) million €)

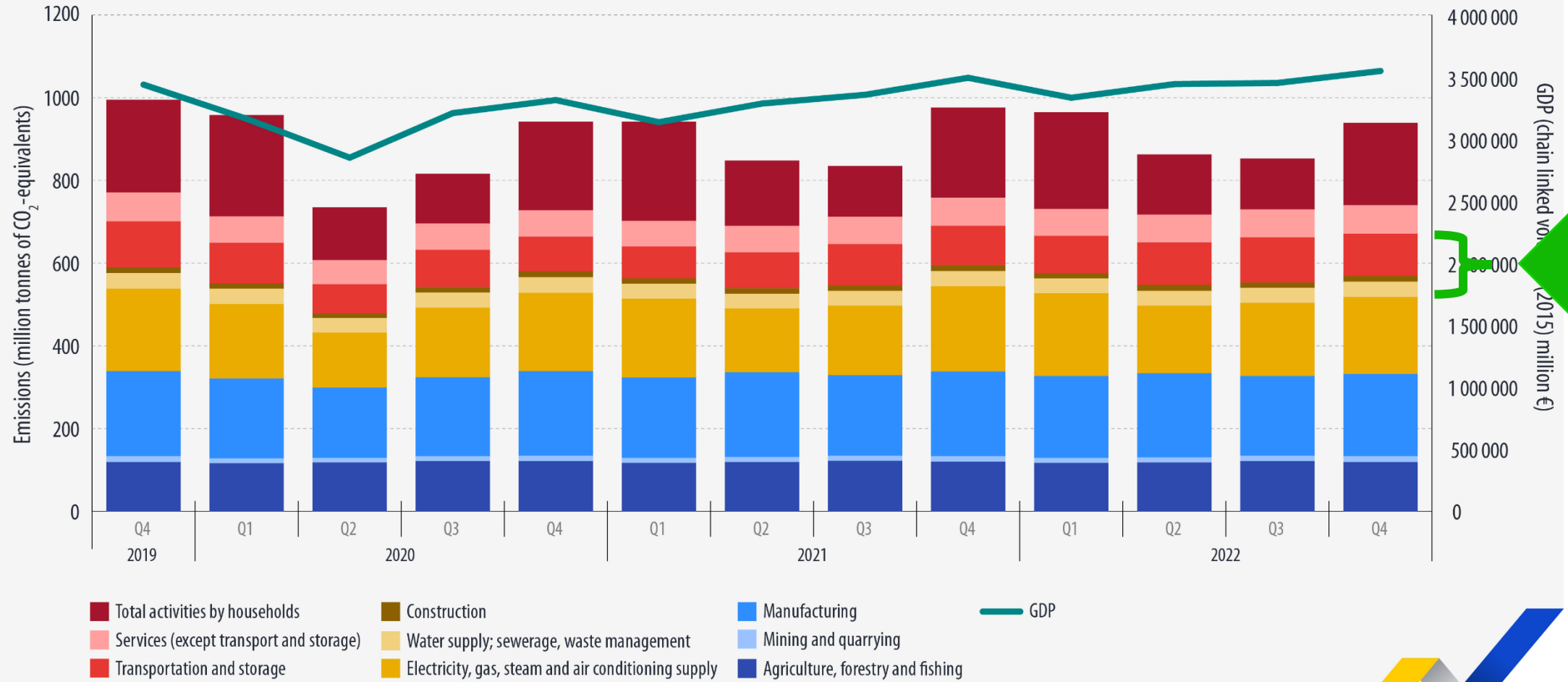

eurostat



Battery pack significance

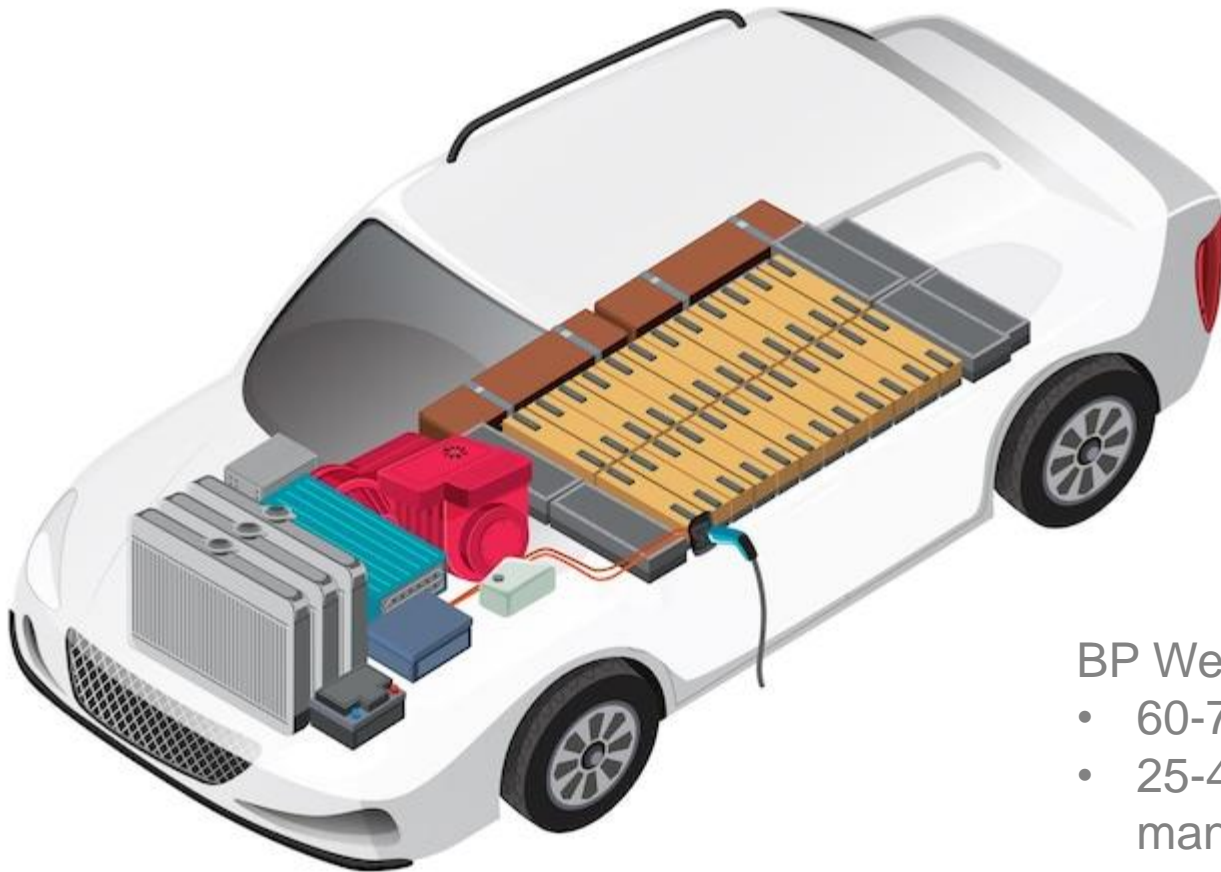

An average Battery Pack (BP) can weight 450-900kg

Materials required in lithium-ion batteries are the chemical components lithium, manganese, cobalt, graphite, steel, and nickel.

BP Weight distribution

- 60-75% cells and the materials they contain
- 25-40% metal casing, cables, and thermal and battery management systems (TMS and BMS).

The MARBEL project



Manufacturing and Assembly of modular and Reusable EV Battery for Environment-friendly and Lightweight mobility

Total budget ~ 12 M€

- > 20% weight reduction
- > 25% charging time reduction
- > 40% LCA improvement by using modularity
- Useful Battery life up to 300,000 km
- Easy & Safe (dis-)assembly automatization
- Reparability and 2nd life transition
- Adaptable to all cells & vehicles

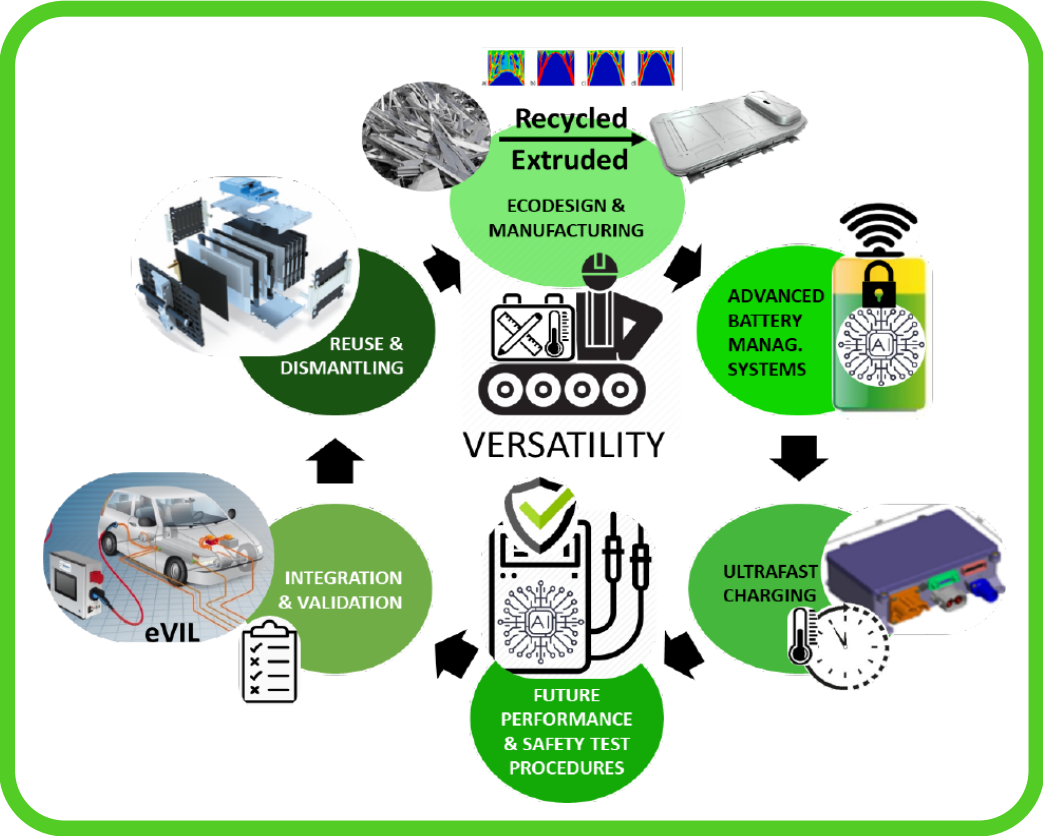

The project is coordinated by EURECAT.



Methodology

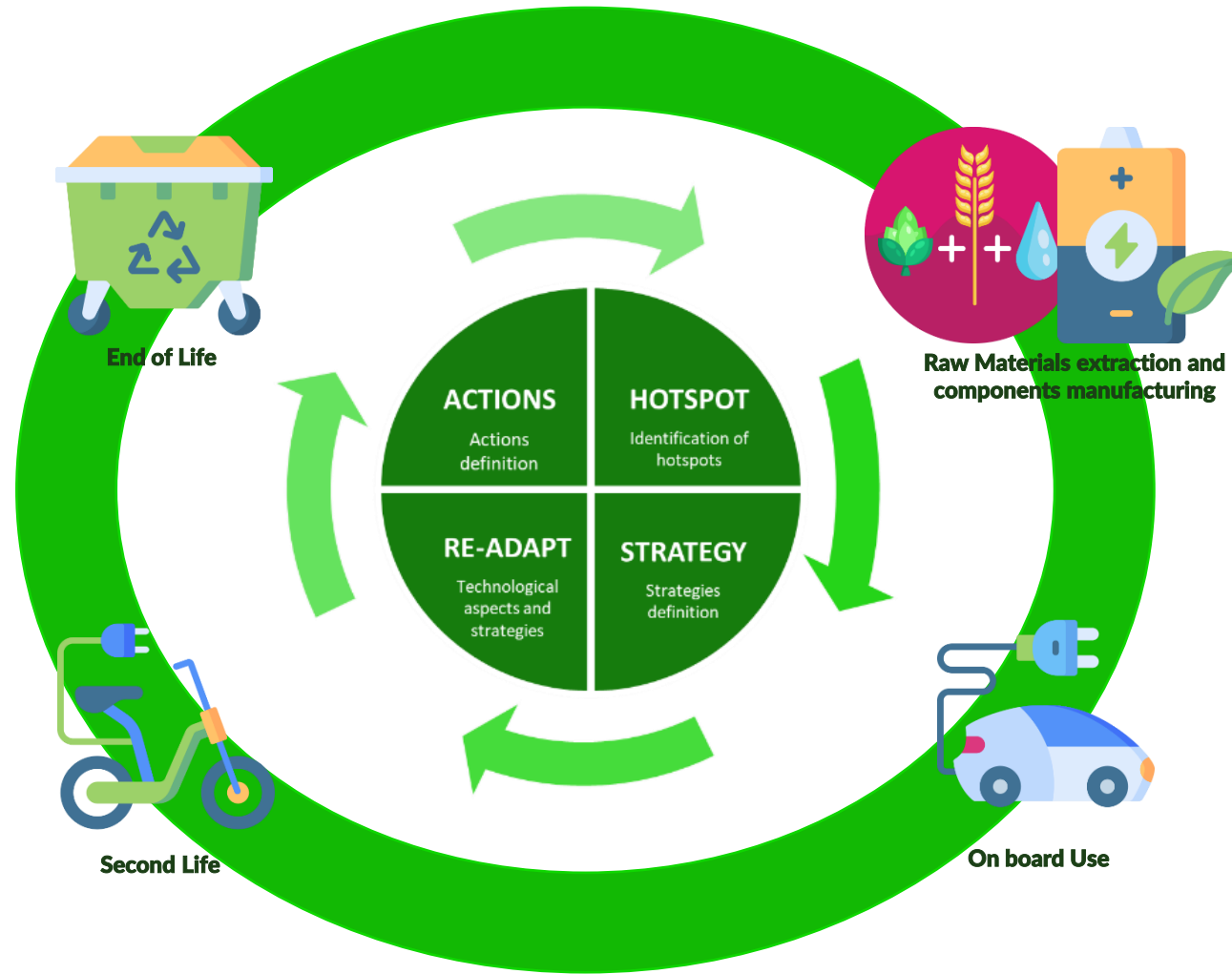



Methodology

STEP 1

- Hotspots and main issues

STEP 1: Identification of Hotspots and Life Cycle Stages

STEP 2: Establishment of the most properly eco-design strategies based on STEP 1

STEP 3: Alignment of technological procedures to the selected strategies

STEP 4: Selection of concrete eco-design actions and Battery Conceptualized Design

Based on a benchmark analysis for conventional products/stages/materials...

With the application of the LCA/LCC in a preliminary manner at the beginning of the project/action/task



Hotspots and main issues



RAW MATERIALS EXTRACTION AND COMPONENTS MANUFACTURING

IMPACT RANGE

30% - 50%

HOTSPOTS & MAIN ISSUES

The contribution coming from the production of structural parts (steel) (Messagie et al)

Presence of metals on the wiring system (copper), and their upstream extraction process (Messagie et al)

Regarding GWP, EV as a whole and the battery mainly, achieve higher impacts in relation to conventional vehicles (Hawkings et al)

The contribution coming from the production of structural parts (Aluminium) (Rinne et al)

Precious metals like nickel, cobalt and manganese are toxic, but allow to increase higher energy densities (Xion shu et al)

Regarding GWP, Battery Management System and energy demand (Fan et al)

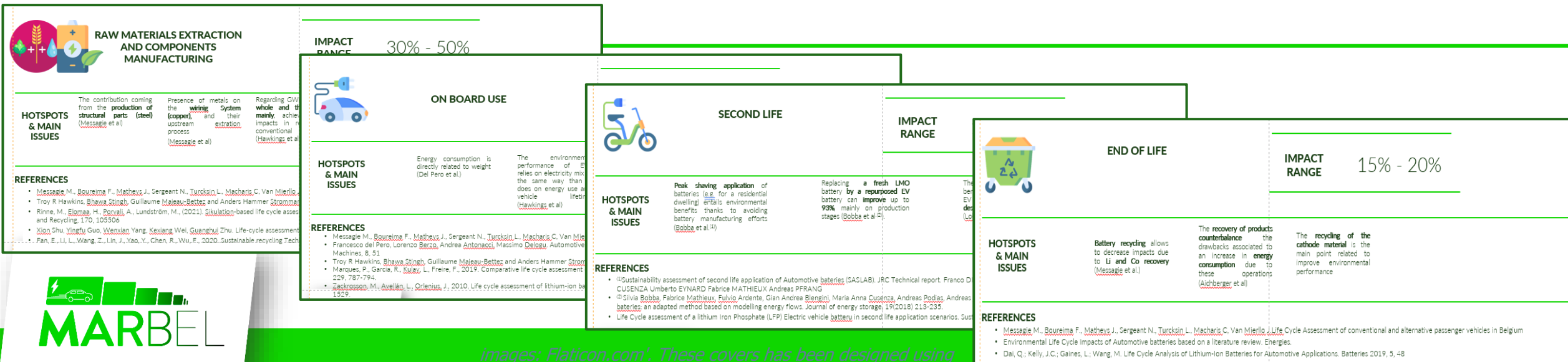



Methodology

STEP 2

- Strategies and set-up

STEP 1: Identification of Hotspots and Life Cycle Stages

STEP 2: Establishment of the most properly eco-design strategies based on STEP 1

STEP 3: Alignment of technological procedures to the selected strategies

STEP 4: Selection of concrete eco-design actions and Battery Conceptualized Design

Focused and aligned with the objectives of the study and coupled to technical actions:

- Design for maintainability
- Lifetime extension
- Use of CRM's substitutes
- Considering second-market resources
- ...

Creating a repository of strategies in datasheet format

Strategies and set-up



STRATEGY 1 Effective material usage: lightweighting



ON STAGE IMPLICATIONS **HIGH** **HIGH** **MEDIUM** **LOW**

ENVIRONMENTAL BENEFITS	Decrease in the use of natural resources	Energy use minimization Reduction potential of CO2 eq emissions	Energy use minimization Reduction potential of CO2 eq emissions potential	Less waste, less material and energy intensity
COST BENEFITS	Less material use implies less cost of components acquisition	Decreasing the intensity of electricity means less energy purchase	Extend battery life minimize the necessity of new storage systems	Costs for components valorisation are lower thanks to an extended amortization

GENERAL DESCRIPTION

Lightweighting is beneficial in designing BEVs as it allows a higher range of energy density for the same cost, or similarly, a smaller battery and motor at constant range and performance. According to the study performed by Lux Research "Electric Vehicle Lightweighting 2030" Lightweighting must cost less than increase BEV range. Otherwise, it will make more economic sense to simply increase pack size. While there is some variation, the cost of lightweighting in 2030 must be less than \$5 per kilogram saved on average.

INNOVATIVE CHALLENGES

As stated by Luk et al (2010), the production of lightweight materials is often more GHG-intensive than the production of conventional materials, which leads to higher vehicle cycle (production) emissions. Therefore, the full life cycle needs to be considered to assess the GHG emission benefits of vehicle lightweighting. At the same time, the lightweight material used and its material substitution ratio (mass of lightweight material required to replace a unit mass of conventional material) must be clearly evaluated to do not obtain biased conclusions.

CONCLUSIONS

The impact of lightweighting on electric vehicles and consequently, on one of the heaviest parts as batteries depends on whether the battery is downsized to maintain driving range, which reduces both vehicle and fuel cycle GHG emissions. This is extremely important to assure the effectiveness of the strategy.

STRATEGY 2 Effective material usage: nature (type of material)



ON STAGE IMPLICATIONS **HIGH** **LOW** **LOW** **LOW**

ENVIRONMENTAL BENEFITS

Lower energy intensity in manufacturing
Decrease toxicity etc

COST BENEFITS

As a rule, materials cheaper

GENERAL DESCRIPTION

Lightweighting is a key strategy to materials currently in use needs materials or low intensity energy

INNOVATIVE CHALLENGES

The material used depends on its may offer superior stiffness while significant weight advantage to other impact vectors, which must

CONCLUSIONS

Any strategy adopted to replace focus on weight reduction. However, regarding the use of hybrid materials, levels of scarcity and / or the to context where the circular economy need to pursue a reduction of overall

STRATEGY 3 Enhancing smart charging options



ON STAGE IMPLICATIONS **NONE**

ENVIRONMENTAL BENEFITS

COST BENEFITS

GENERAL DESCRIPTION

According to ISO 15118, vehicle-to-grid controls for the integration of renewables and potential low energy and consequently, decreasing renewables ranges. And this, could be reduced, increasing the efficiency with a higher rate in renewables.

INNOVATIVE CHALLENGES

BEVs require 6 - 12h for 80% battery during the vehicle life, but manufacturer short thermal stresses due to fast voltage measure has the risk to require of ultrafast and accurate met

CONCLUSIONS

Electric vehicles can contribute to the

STRATEGY 4 Improve monitoring and state of cell and their capacity



ON STAGE IMPLICATIONS **LOW** **HIGH** **HIGH** **NONE**

ENVIRONMENTAL BENEFITS

Energy savings while driving

Reduce the number of tests to be carried out to find out the status of battery to decide the most suitable second life application.

COST BENEFITS

Energy saved and potential elongation of the lifespan of the battery to allow 1 replacement /300000 km

Reduce the costs associated to determine the SoC of potential batteries candidates for second life.

GENERAL DESCRIPTION

This strategy aims at achieving a comprehensive information on the status of the battery by analysing the status of each cell. This information can be collected by the BMS that should be capable to use this information to act accordingly to use the cells that are in better conditions. Identify which cells have degraded and calculate the current capacity of the battery. This information should be available by downloading the data sets by any battery operator system.

INNOVATIVE CHALLENGES

Define an algorithm for the BMS capable to extract the information of each cell and decide the operational use to maximise the efficiency and/or lifespan of the battery. The BMS shall also be capable to collect and prepare this information to be provided once the battery ends its first life in the vehicle.

CONCLUSIONS

Constant monitoring and accessibility to data on the status of the battery and cells provides information that will



Methodology

STEP 3

- Re-adapt to feasibility

STEP 1: Identification of Hotspots and Life Cycle Stages

STEP 2: Establishment of the most properly eco-design strategies based on STEP 1

STEP 3: Alignment of technological procedures to the selected strategies

STEP 4: Selection of concrete eco-design actions and Battery Conceptualized Design

To procure adapt the technical perspective to the environmental sphere (and vice versa)

HOW? Workshop where all parties involved begin to be familiarized with eco-design concepts

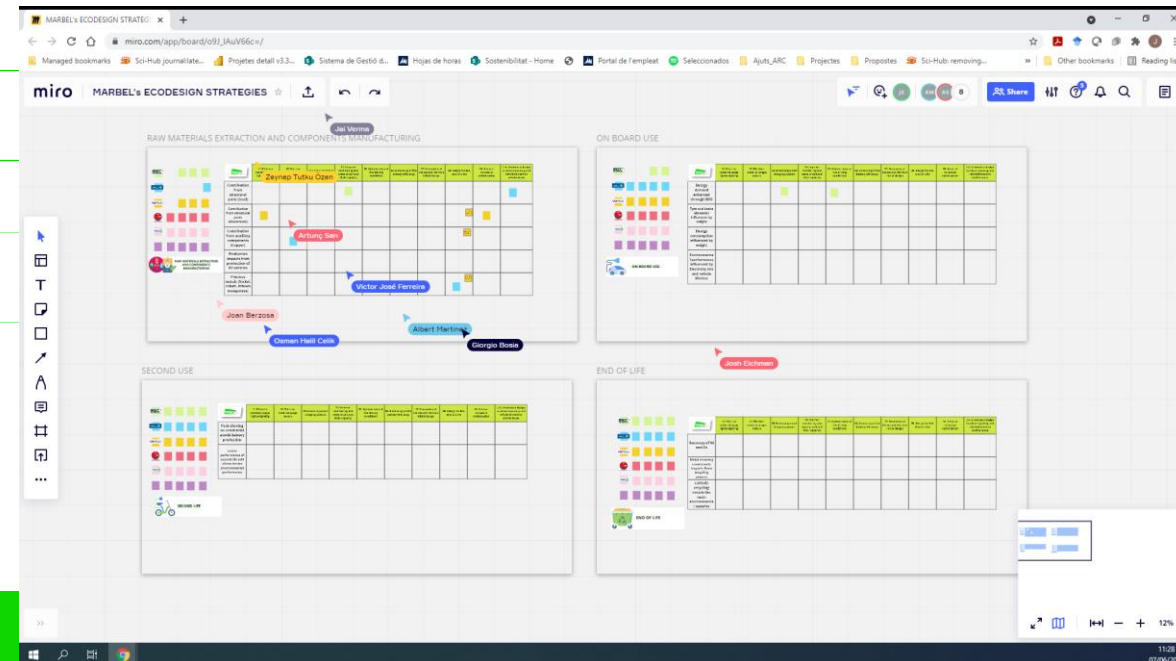



ECODESIGN STRATEGIES

- S1 Effective material usage: lightweighting
- S2 Effective material usage: nature
- S3 Enhancing smart charging options
- S4: Improve monitoring and state of cell and their capacity
- S5: Optimization of the driving conditions
- S6: Enhancing of the battery efficiency
- S7: Promotion of the second life from initial design
- S8: Design for EoL (End of life)
- S9: General structure optimization
- S10: Promote a design to allow repairing and refurbishment to enable reuse



Methodology

STEP 4

- Specific actions

STEP 1: Identification of Hotspots and Life Cycle Stages

STEP 2: Establishment of the most properly eco-design strategies based on STEP 1

STEP 3: Alignment of technological procedures to the selected strategies

STEP 4: Selection of concrete eco-design actions and Battery Conceptualized Design

From the strategy to action, in other words: define clearly what technical specific activities are proposed and “translate it” into the environmental sphere

Actions



Action 1: Use of recycled and recyclable materials, for example, in the extrusion of Aluminium profiles.

Action 2: Reduction of copper material needed for electronic components (cables, wirings, etc.)

Action 3: Adopt a "design for reuse, dismantling and recycling" approach by using easy recoverable and recyclable materials instead hybrid ones.

Action 4: Topological optimization of profiles to be used in the BP housing. This simulation will calculate the minimum material necessary to comply with the mechanical requirements.

Action 5: Reduce the quantities of soldering parts of the battery to minimize use of resources and facilitate end of use and second life operations.

Action 6: Use joining elements that can easily be removed to facilitate disassembly, as screws instead of glues to seal the battery pack /modules case.

Action 7: To define and include a protocol for the disassembly operations to assure safety conditions.

Action 8: Introduce a weldless connection to the cells to support disassembly, repairing, etc, options.

Action 9: Reduce whole weight of the battery by using lightweight materials in the casing elements (Al, Mg alloys,) and by choosing a high gravimetric energy chemistry in the electrodes composition that reduces the mass and keeps the energy capacity of the battery.

Action 10: An enhanced BMS that provides advanced degradation rate estimations to optimize battery usage in terms of an extended lifespan.

Action 11: Design a BMS with a multipurpose approach for both primary and second life options of the battery.

Action 12: To create a cloud connecting environment where data associated to the battery could be downloaded at any time during its lifetime and 2nd life extension.

Action 13: Develop a BMS able to respond second life applications by connecting to 200 modules.

Action 14: Adopt a battery pack design able to be easily repaired, refurbished, and reused with limited interventions.

This is how is measured



Life Cycle Assessment

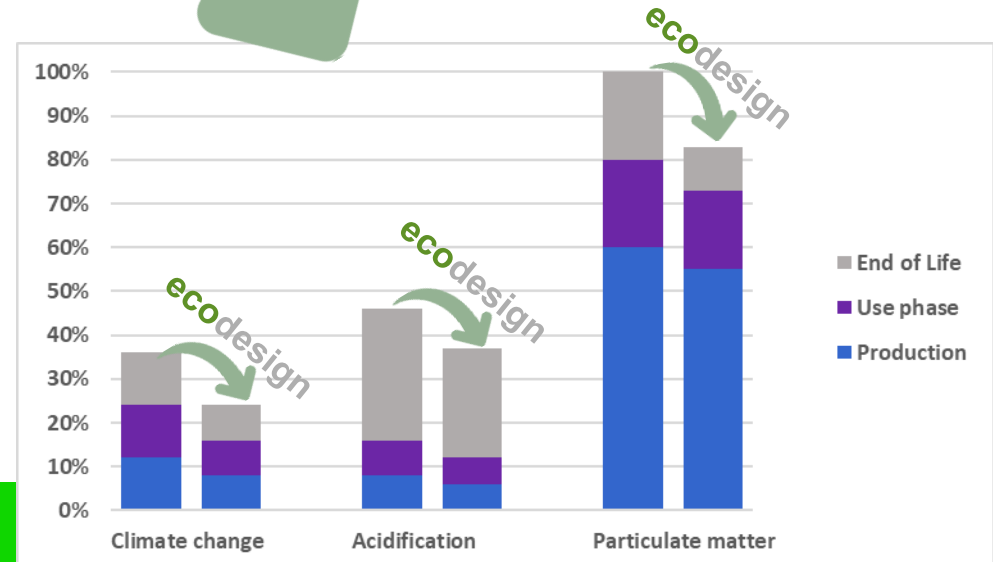
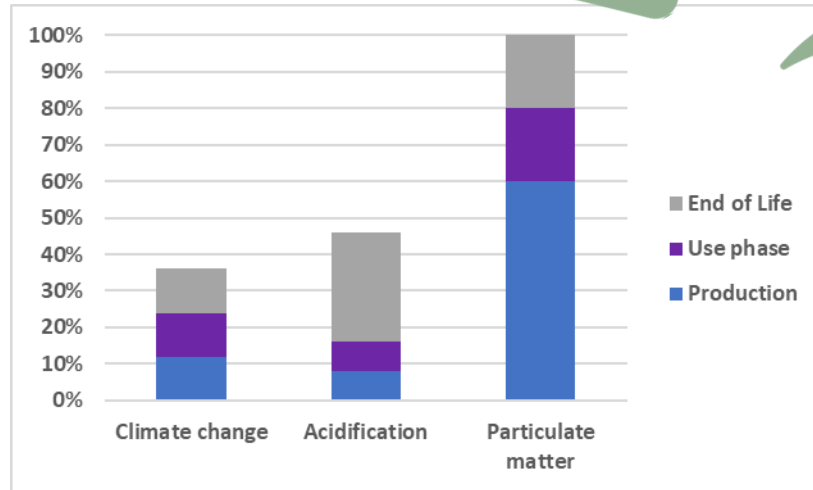
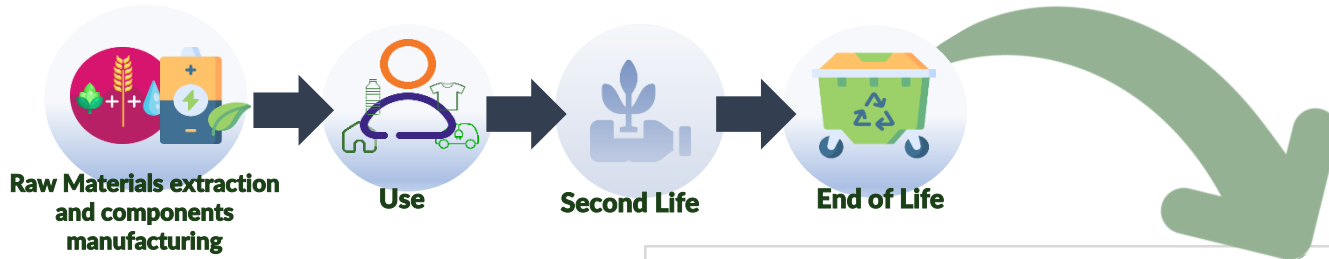

Methodology



**Cradle-to-grave
(1st and 2nd life)**

1 kWh

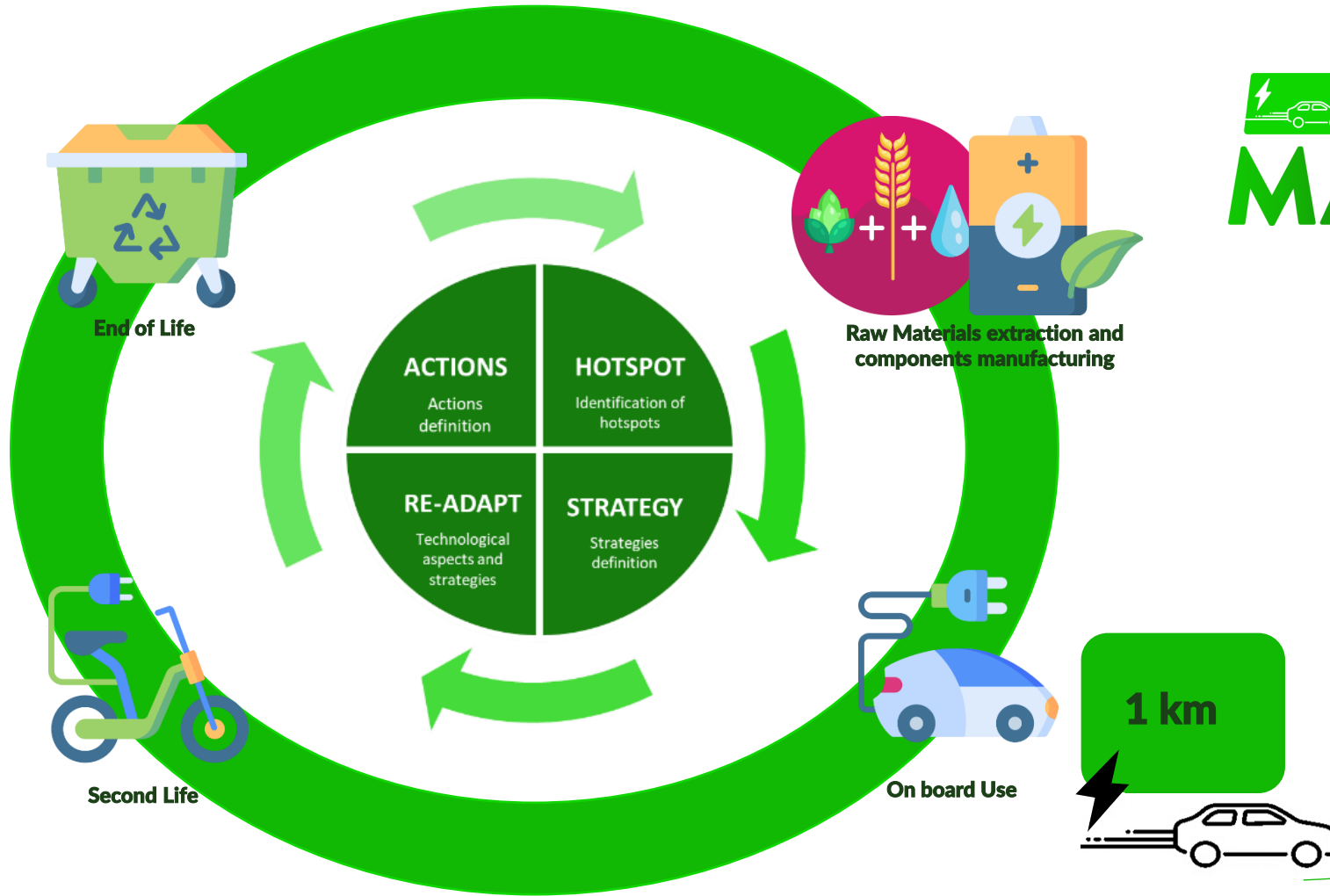
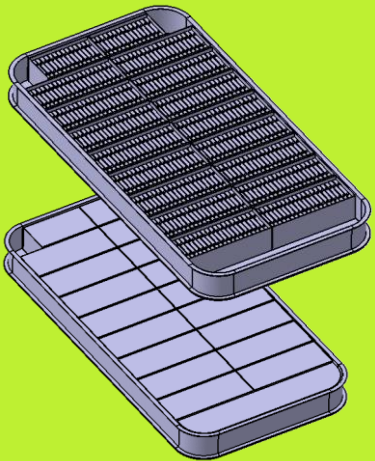

**Cradle-to-gate
(1st life)**





1. To **quantitatively assess** the effects of processes and products on the environment.

2. To identify and prioritize **the elements with the most** environmental impacts for further improvement.

3. To develop **robust and numerically supported** impact reduction plans.

4. To communicate and report the environmental performance through **standardized methods**.

Conclusions



- Key environmental concerns related to LIB batteries in electric vehicles are identifiable through ecodesign and LCA combined
These concerns encompass:
 - material selection (including critical resources like CRM),
 - weight considerations,
 - electrical composition,
 - vehicle lifespan,
 - savings derived from reusing EV batteries, and
 - the recovery of valuable elements like Li and Co for end-of-life impact reduction.
- A collaborative ecodesign approach can lead to more sustainable, efficient, and cost-effective solutions, benefiting both the environment and the automotive industry
 - designers can identify and mitigate environmental impacts at each stage.
 - choosing materials with lower environmental impact, higher energy efficiency, and recyclability can contribute to a more eco-friendly battery pack.
 - diversity can foster innovation and lead to the development of more efficient and high-performance battery packs.
 - collaboration can facilitate the development of strategies to optimize the use and maintenance of battery packs, potentially extending their lifespan.



**Manufacturing and assembly of
modular and reusable EV
battery for environment-friendly
and lightweight mobility**

THANK YOU!

PRESENTER NAME: Violeta Vargas (EURECAT)

EMAIL: violeta.vargas@eurecat.org

DATE: December 5th, 2023



A project coordinated by:

eurecat



COLLABAT

WEBINAR

LIFE CYCLE ASSESSMENT

The Priceless Value of LCA in the Circular Economy and its Influence in the Battery Industry

5
DEC

From 9:00 to 11:00 CET



REGISTER NOW

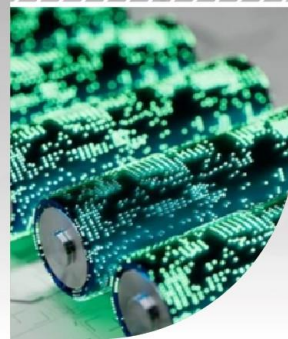

Powering Up Recycling in LCA and its Impact on the Battery Industry



This project has received funding from the European Union's Horizon 2020 research and innovation programme under grant agreement No 963646



Victor Ferreira,
IREC, Spain



This document reflects the view of its author(s) only. The funding agency is not responsible for any use that may be made of the information it contains.



Growing demand for batteries in electric vehicles and electronics

Increasing prevalence of EVs heightens the need for sustainable battery lifecycle management

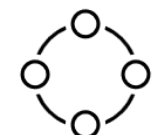

- ❑ **Battery Technology:** improving battery performance and reducing the need for rare earth metals
- ❑ **Charging Infrastructure:** essential for the widespread adoption of EVs
- ❑ **Cost Reduction:** economies of scale and government incentives)
- ❑ **Supply Chain:** Ensuring a sustainable and ethical supply chain
- ❑ **Enhanced Recycling and 2nd Life:** sustainable and efficient recycling process and repurposing for these batteries



16.5 million
electric vehicles on the road in 2021 ^{*}

Global



5.5 million
electric vehicles on the road in 2021

EU-28

30 million vehicles in 2030
Expected growth

1

3

“Demand for lithium-ion batteries projected to grow over 30% annually, reaching a market size of 4.7 TWh by 2030”

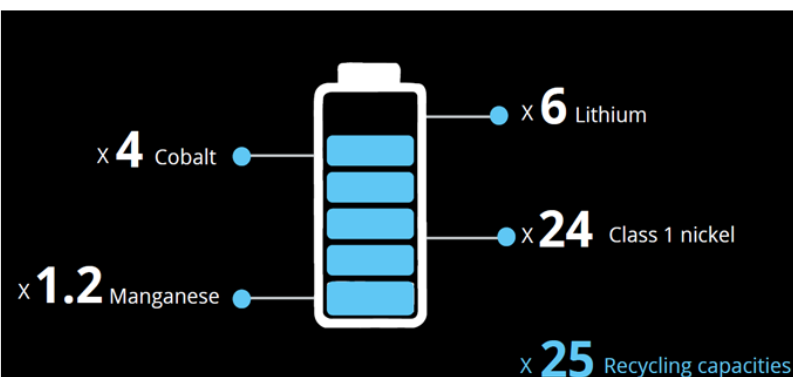



Need for sustainable and circular battery production and recycling

Battery Recycling as a Key Component

- ❑ Recycling Importance: Sustainable battery recycling is critical for **reducing reliance on raw material extraction and decreasing environmental footprint.**
- ❑ System-Wide Impact: **Decisions in battery design, usage, and end-of-life protocols significantly influence recycling efficacy**
- ❑ Recycling Challenges: Addressing the **safe and efficient recycling of a growing number of EV batteries**

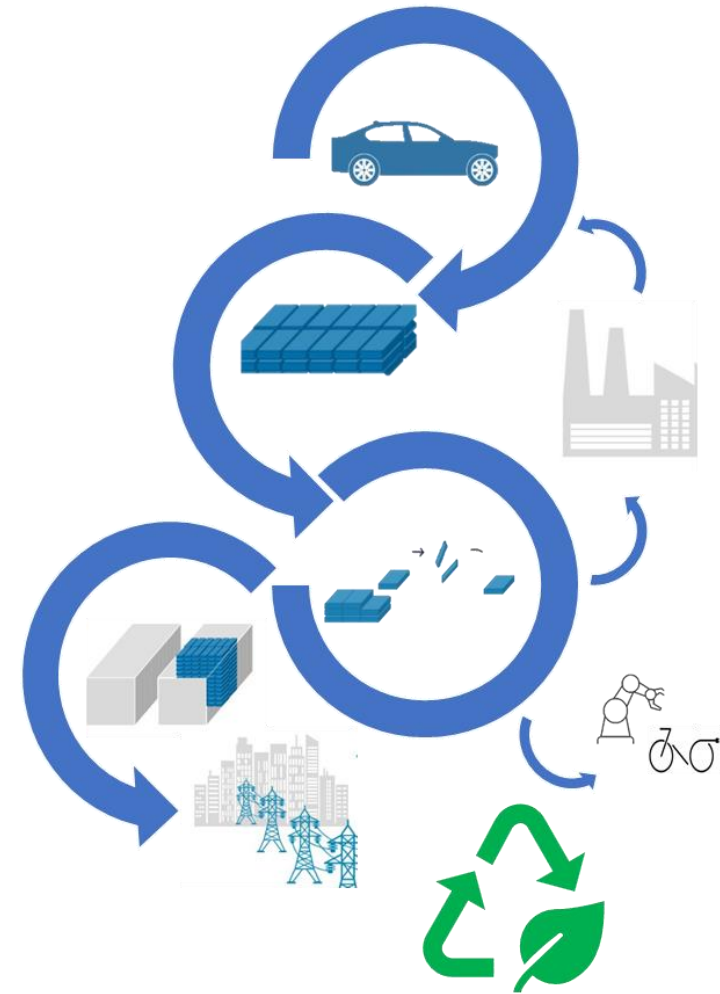



Role of life cycle assessment in identifying hotspots and driving innovation

Impact on battery recycling



Current recycling rates are low due to technical and economic challenges



LCA identifies opportunities to improve recycling processes and technologies



Battery design for recyclability (modularity, separability, material coding)



Closing the loop: reuse of recycled materials in new batteries

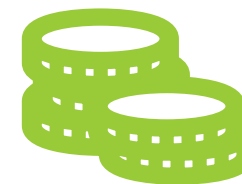

Role of policy and incentives in driving higher recycling rates

70% of emission and energy consumption can be reduced by extracting the materials and components by recycling
This overall percentage can be increased up to 91% (combination of mechanical and hydrometallurgical processes)



<https://www.helios-h2020project.eu/>



Total Budget

€ 9 993 975,25

Duration 2021 -2024



High-performance modular battery packs for sustainable urban electromobility services

- ❑ Hybrid combination of High Energy with High Power cells in one pack
- ❑ Modular & Scalable design combining different battery modules & DC/DC
- ❑ Advanced BMS and Multi-Sensor – Unit using Wireless communication
- ❑ Digital Twin, IoT Cloud based solutions, Fleet management software
- ❑ Ultrafast – charging at 360 kW

The project involves several leading battery manufacturing organisations and aims to demonstrate the battery technology (battery pack) on a) small city EV car and b) a full-size Bozanka e-Bus



vtlesco
TECHNOLOGIES



idneo





LCA in HELIOS to support the Circular Economy

End of Life (EoL)

- ❑ Development of new innovative procedure for robotic battery disassembly at the end of the life.
- ❑ Performance in 2nd life applications: stationary storage.
- ❑ In Life Cycle Assessments (LCA), evaluating recyclability and environmental aspects emphasizing the significance of housing materials, which contribute significantly to weight and overall.
- ❑ Recyclability analysis of EoL battery packs. Metal recovery
 - Recycling of HELIOS cell chemistries (NMC/LTO)

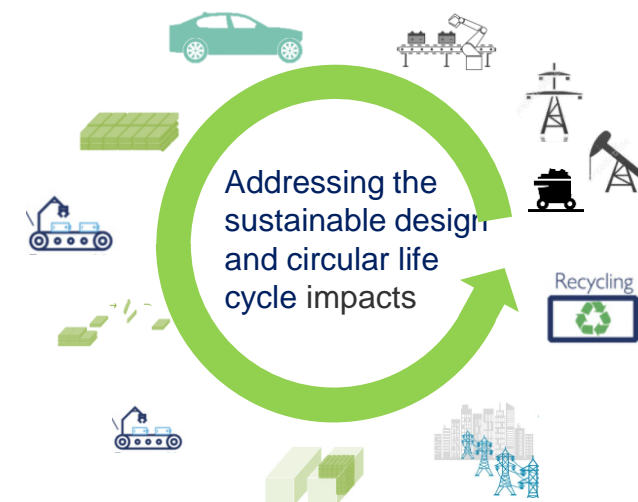

Full LCA calculations
related to HELIOS
innovations





HELIOS recycling processes

The potential of **froth flotation** was studied as a recycling step combined with **hydrometallurgical recycling** of an NMC811-graphite-LTO mixture

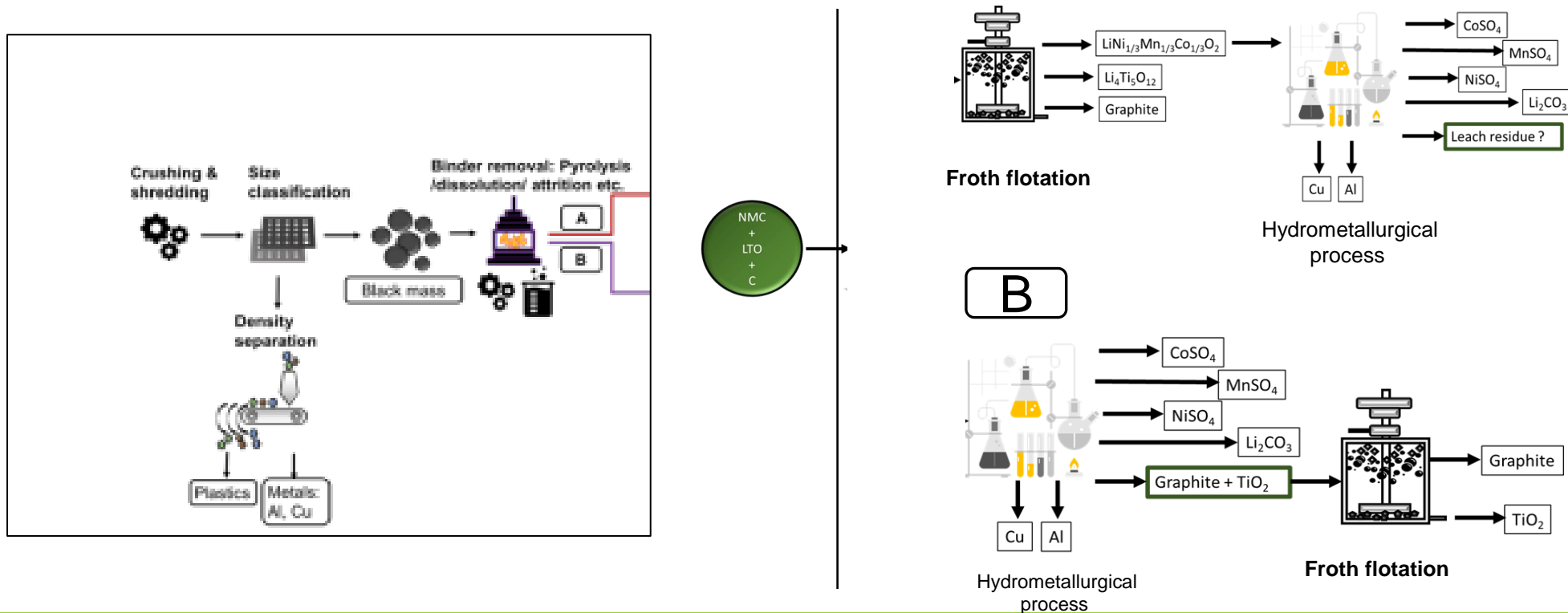



HELIOS recycling processes

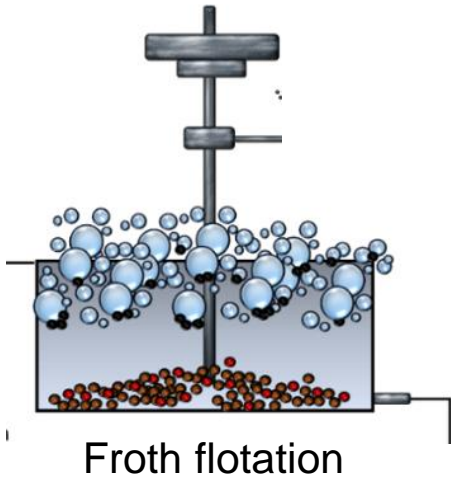

- ❑ Froth flotation separates lithium metal oxide from graphite based on their different wettability properties, with bubbles introduced into a stirred container to create a graphite-rich froth.
- ❑ Since froth flotation is a physical separation method, preserving the graphite structure for direct reuse in new batteries.
- ❑ Preliminary laboratory experiments indicated that, for a sample consisting of 50wt% NMC811, 25wt% LTO, and 25 wt% graphite, an average of approximately 52wt% of graphite was successfully recovered with a grade of 98%.
- ❑ Further research is required to consistently achieve grades exceeding 99%.

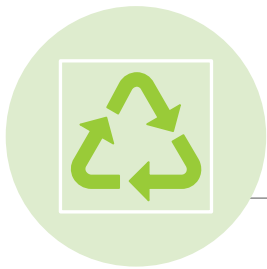

LCA model in HELIOS to recover materials

Goal and Scope

- ❑ Determine the environmental impacts of the hydrometallurgy process for battery recycling proposed for the black mass with high nickel content.

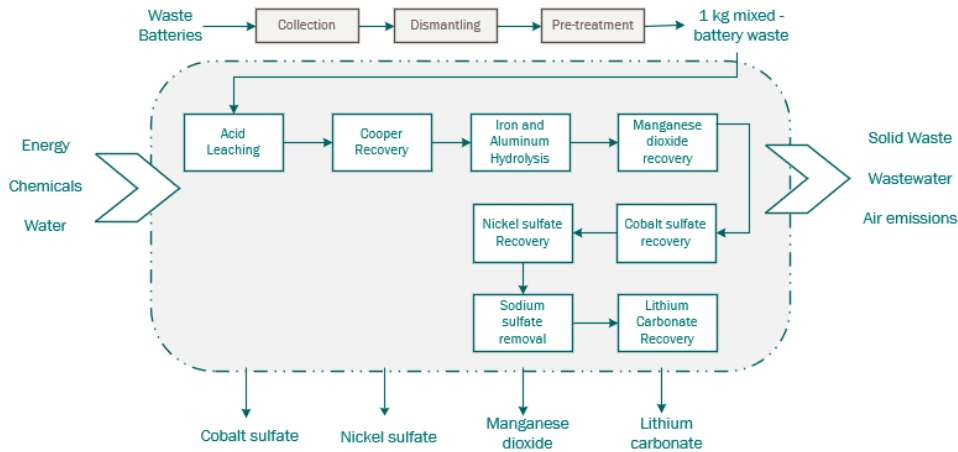

- ❑ The functional unit selected is **1 kg of recycled black mass**
- ❑ Chemistry® Sim software module (METSO, Pori, Finland) was utilized to obtain the life cycle inventory (LCI) of the emerging hydrometallurgy recycling process

Data are from manuscripts that are currently in preparation by Sahlvirta et al., Waste Management in preparation and Arellano et al., International Journal of Life Cycle Assessment

Life cycle Inventory (LCI)

- ❑ Materials

Leaching
Black mass
Sulfuric acid
Hydrogen peroxide
Copper Cementation
Iron scrap
Iron-Aluminium removal
O _{2(g)}
NaOH
Manganese Recovery
Manganese sulphate
Sulfuric acid
NaOH
O _{2(g)}
SO _{2(g)}
Cobalt Recovery
Cobalt Sulphate
Sulfuric acid
NaOH
Nickel Recovery
Ni
Sulfuric acid
NaOH
Lithium Recovery and Na₂SO₄ Removal
Na ₂ CO ₃
NaOH
Effluent Treatment
Lime
Energy
Steam
Water

- ❑ Material recovered from the software simulations and their purities (%)

Material	Purity	Unit
MnO ₂	98.41	%
Li ₂ CO ₃	97.79	%
NiSO ₄	99.61	%
CoSO ₄	99.34	%

Environmental Impact indicators

Abbreviation	Impact category
GWP	Global Warming Potential
ADP	Abiotic depletion (elements)
ADPf	Abiotic depletion (fossil)
AP	Acidification potential
EP	Eutrophication potential
FW-AE	Fresh water aquatic ecotoxicity
MA-EX	Marine aquatic ecotoxicity
ODP	Ozone depletion
POCP	Photochemical ozone creation potential
T-EX	Terrestrial ecotoxicity
FPM	Particulate matter
LU	Land use
HT-C	Human toxicity potential – Cancer
HT-NC	Human toxicity potential – Non-Cancer

- ❑ Open LCA software by Green Delta
- ❑ The Ecoinvent 3.6 database



LCA model in HELIOS to recover materials

Results

Impact category	Unit	Value
GWP	kg CO₂ eq	3.66
ADP	kg Sb eq	2.14 x 10 ⁻⁴
ADPf	MJ	50.40
HT-C	cases	3.43 x 10 ⁻¹⁰

- ❑ For GWP, the more important contributors were associated to the use of sodium hydroxide, nickel sulphate, hydrogen peroxide and the generation of steam.
- ❑ ADP contributions were nickel sulphate 50% and sodium hydroxide and sulfuric acid with ~19%.
- ❑ ADPf contributions were related to the use of sulfuric acid (21%), sodium hydroxide (28%), steam and hydrogen peroxide (~11%).
- ❑ HT-C Sodium hydroxide 23%, hydrogen peroxide 27%, nickel sulphate 19%, steam, soda ash and sulfuric acid ~8%



Full Cradle-to-Grave LCA calculations
related to HELIOS battery innovations

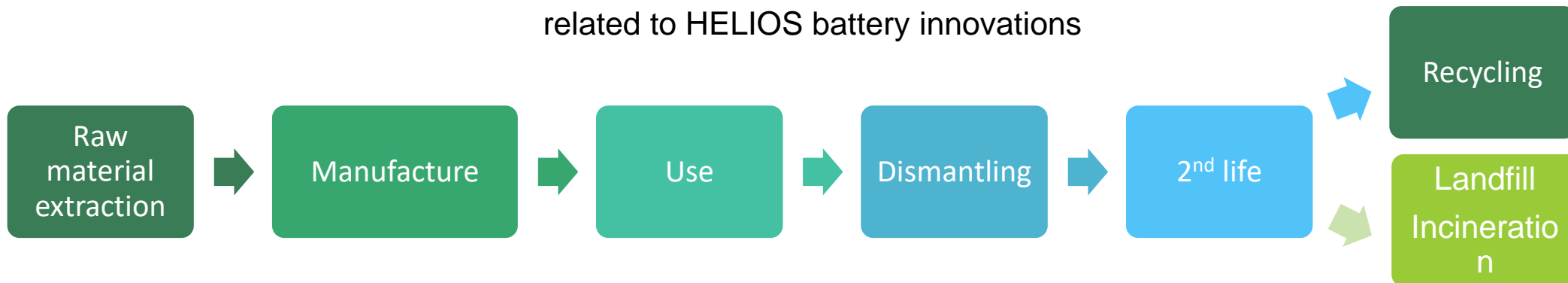



LCA in HELIOS to support the Circular Economy vs New EU regulation

EU regulation in the End-of-life Management

- Existing collection obligations on producers of **automotive batteries, industrial batteries and electric vehicle batteries** will be reinforced by introducing specific reporting obligations to facilitate enforcement.

LCA methodology

EoL models include:

- Battery collection logistics related mainly the **transportation** to the place of waste management, recycling, other treatments, etc.
- Environmental allocation for credits** when considering recycling

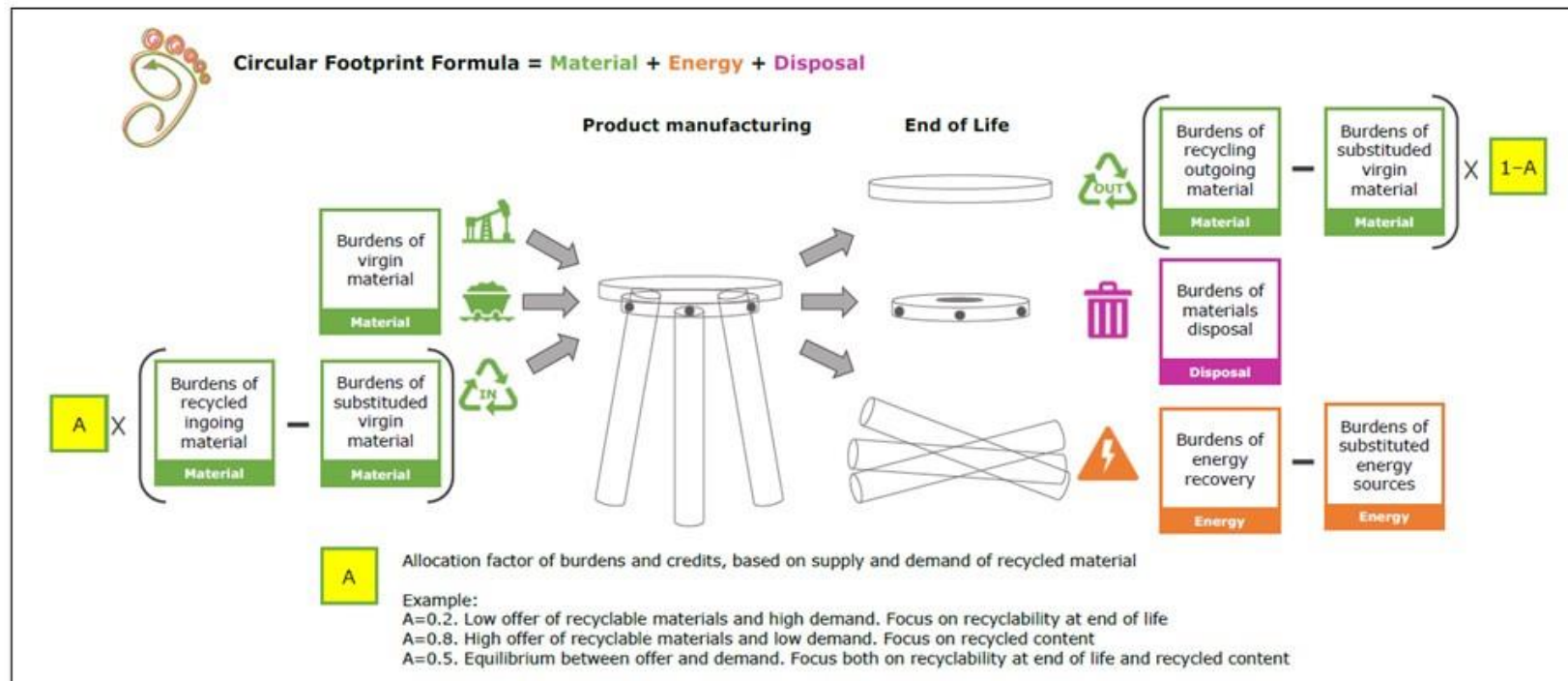



LCA in HELIOS to support the Circular Economy vs New EU regulation

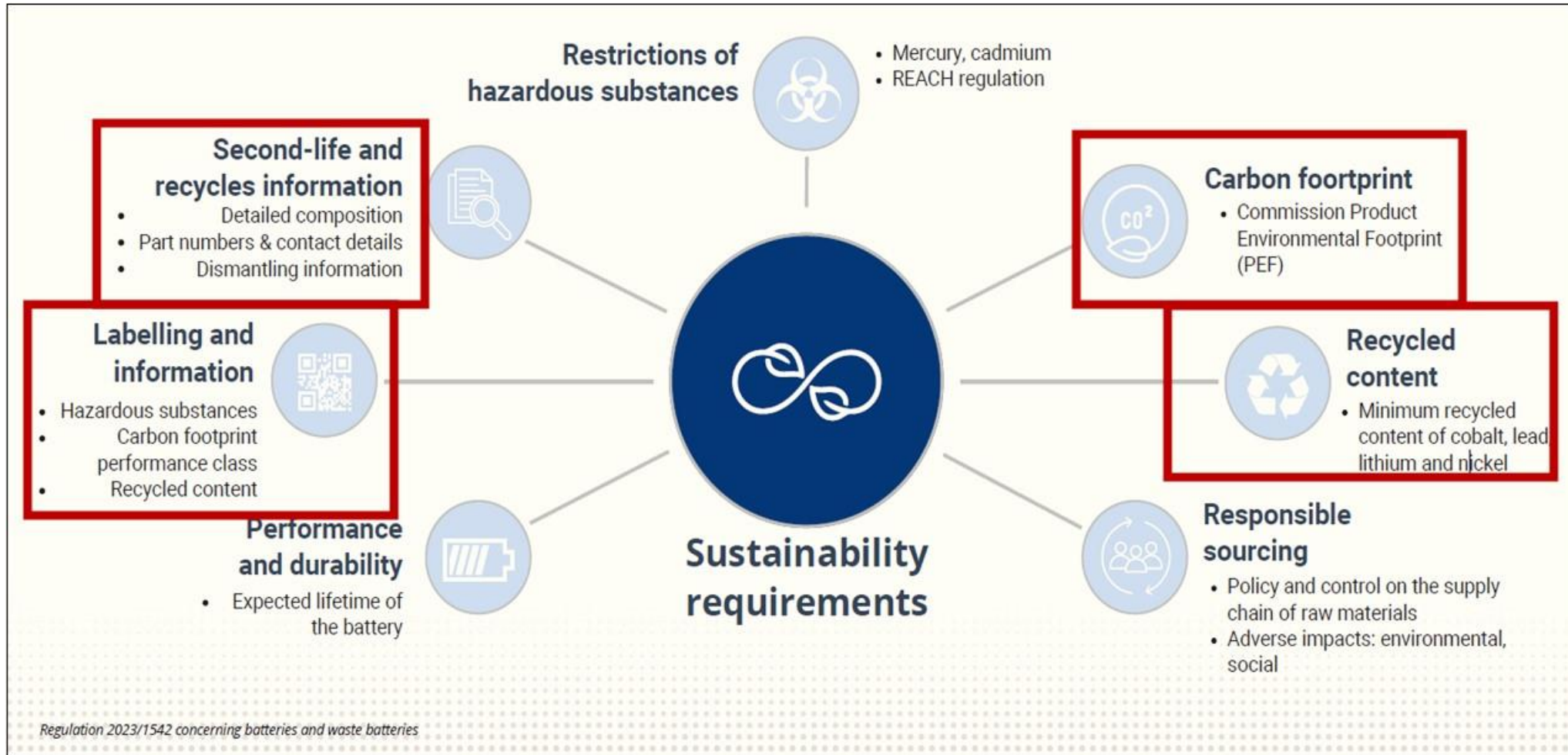



LCA Impact on HELIOS Battery Recycling

- ❑ Anodic graphite makes up 14-22% of the weight of lithium-ion batteries (LIBs). Froth flotation has the potential to be used for recycling if this anodic material, can contribute to meeting future EU recycling regulations.
- ❑ The HELIOS hydrometallurgy simulation process shows a reasonable recovery percentage of Li, Mn, Ni, and Co, ranging between 98.41% and 99.60%.
- ❑ The LCA management to be developed in HELIOS will support the inclusion of sustainability and circularity-related information within the New EU regulation, addressing aspects such as environmental impacts related to the performance recycling processes being developed in HELIOS project.



Victor Ferreira



vjferreira@irec.cat



IREC^R
Shaping Energy for a Sustainable Future
<https://www.irec.cat/>



This project has received funding from the European Union's Horizon 2020 research and innovation programme under grant agreement No 963646

This document reflects the view of its author(s) only. The funding agency is not responsible for any use that may be made of the information it contains.



Life Cycle Analysis of Advanced Light Weight battery system for electric vehicle

Dr M A Hye Chowdhury

Technovative Solutions Ltd



ALBATROSS Project

Advanced Light-weight BATteRy systems Optimized for fast charging, Safety, and Second-life applications.



ALBATROSS – Overall Objective

The overarching aim of ALBATROSS is to create advanced battery pack designs and systems that can achieve:

- Peak Energy Density of >200 Wh/kg for i3, an improvement of 50% against the current 152 Wh/kg.
- 20% weight reduction of the battery system equating to 56kg weight reduction for i3 battery system to 222kg (currently 278kg),
- 25% charging time reduction down to 30 minutes (40 minutes currently, 20-80%) using 150kW charger – Relating to a Charge Rating of >4C, compared to state of the Art ~2C.
- Increase driving range up to 480 km (285-310 currently).
- A 15-20% improvement over the full lifecycle and to precisely determine the End of Life (EoL) of electric vehicles according to the State of Health (SoH) and 98% of driving range trips done historically by the driver.
- Extensive knowledge improvements in pack sensor and thermal management leading increased battery pack lifetime and to ease of thermal component dismantling and repurposing for second life/recycling.

1 Database and literature information to the LCA study

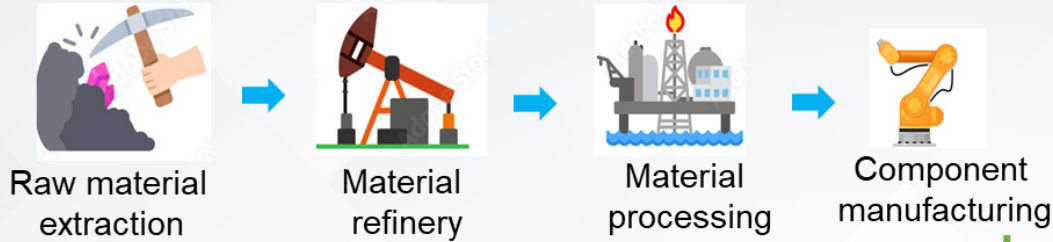

- 1 Related data will be extracted from the standard database and literature.
- 2 Albatross project data will be used. Supporting data will be extracted from the standard database and literature.

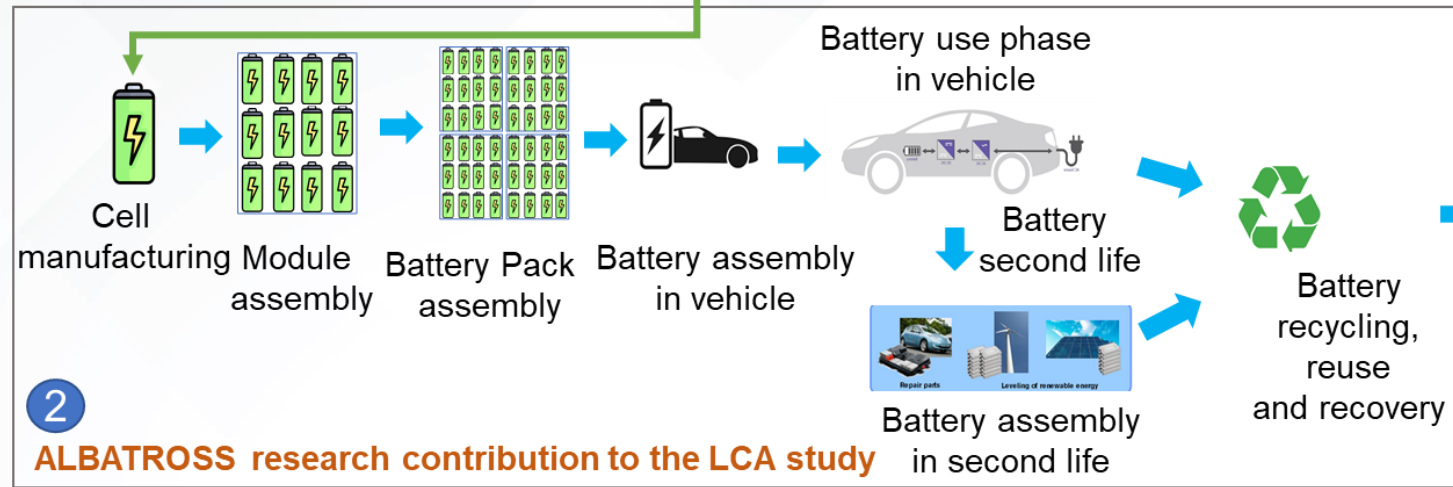

ALBATROSS concept - 'cradle to grave' life cycle assessment study

Cradle to Gate LCA

LCA Workplan:

- LCA of Battery Cell
- LCA of Battery Management System (BMS)
- LCA of Battery Enclosure
- LCA of Thermal Management System

Functional Unit: 1 kWh capacity or 1 kWh Energy delivered or 1 km travelled

Database: ecoinvent v 3.9.1

LCIA Methodology: IMPACT World+ Midpoint V1.03

ALBATROSS – Battery Assembly

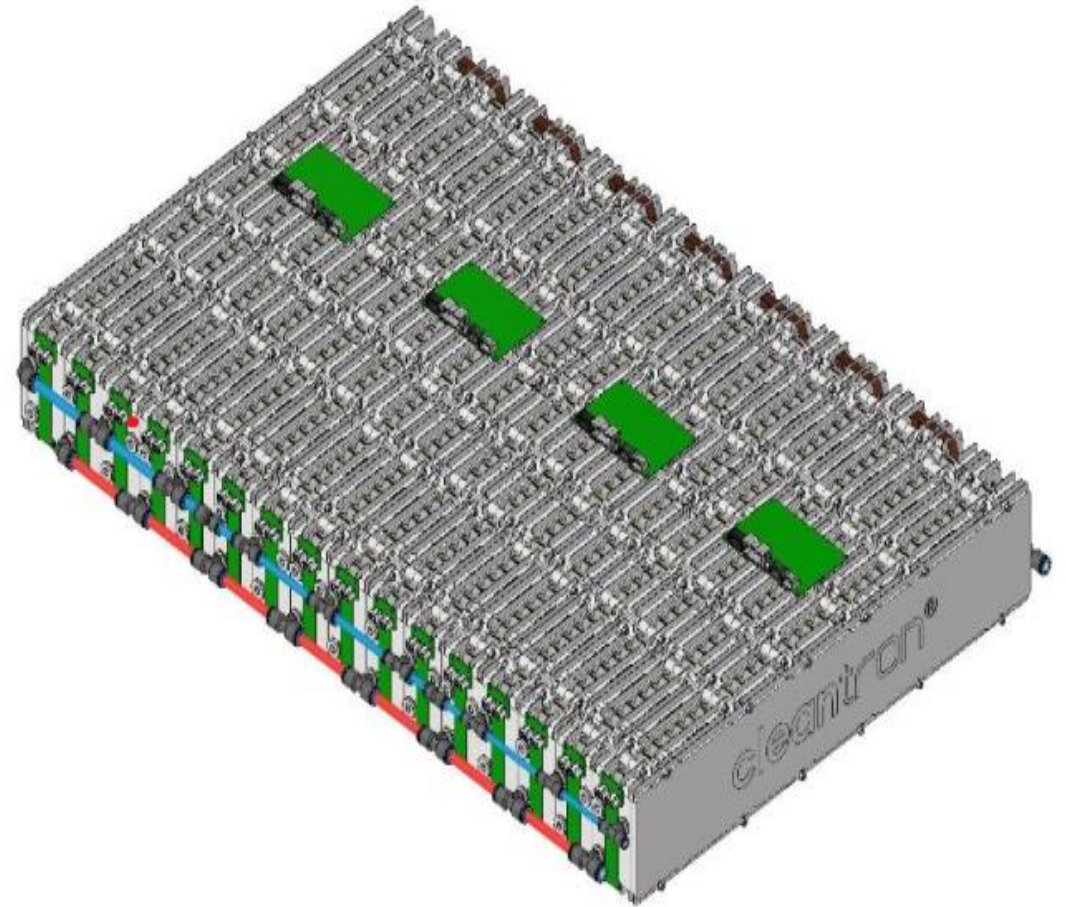

ALBATROSS System

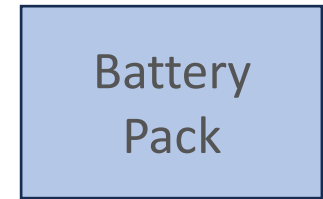
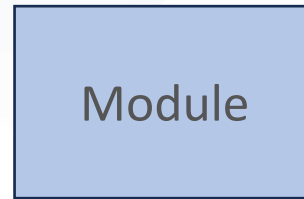
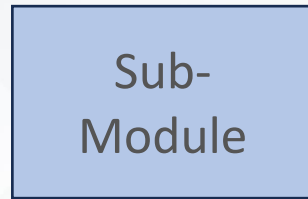
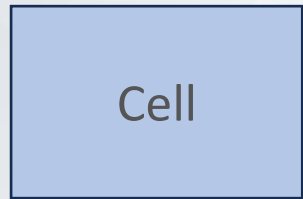

Type: Cylindrical

32 parallel * 6 Series
= **192 Cells** in a sub-
module

4 Sub-modules creates
1 module

16 Sub-Modules
= 4 Modules
=1 Battery Assembly



Assembly of the model (FU 1 kWh Capacity)

Name	Status	Comment			
Construction_ALBATROSS_System_1 kWh	None				

Materials/Assemblies	Amount	Unit	Distribution	SD2 or 2SD	Min
Battery cell_1 kWh	1	p	Undefined		
Battery enclosure_1 kWh	1	p	Undefined		
ThermalManagementSystem_1 kWh	1	p	Undefined		
BatteryManagementSystem_1 kWh	1	p	Undefined		

Processes	Amount	Unit
-----------	--------	------

The carbon footprint of ALBATROSS Battery system comprising battery cell, battery enclosure and management systems

Functional unit: 1 kWh of battery capacity

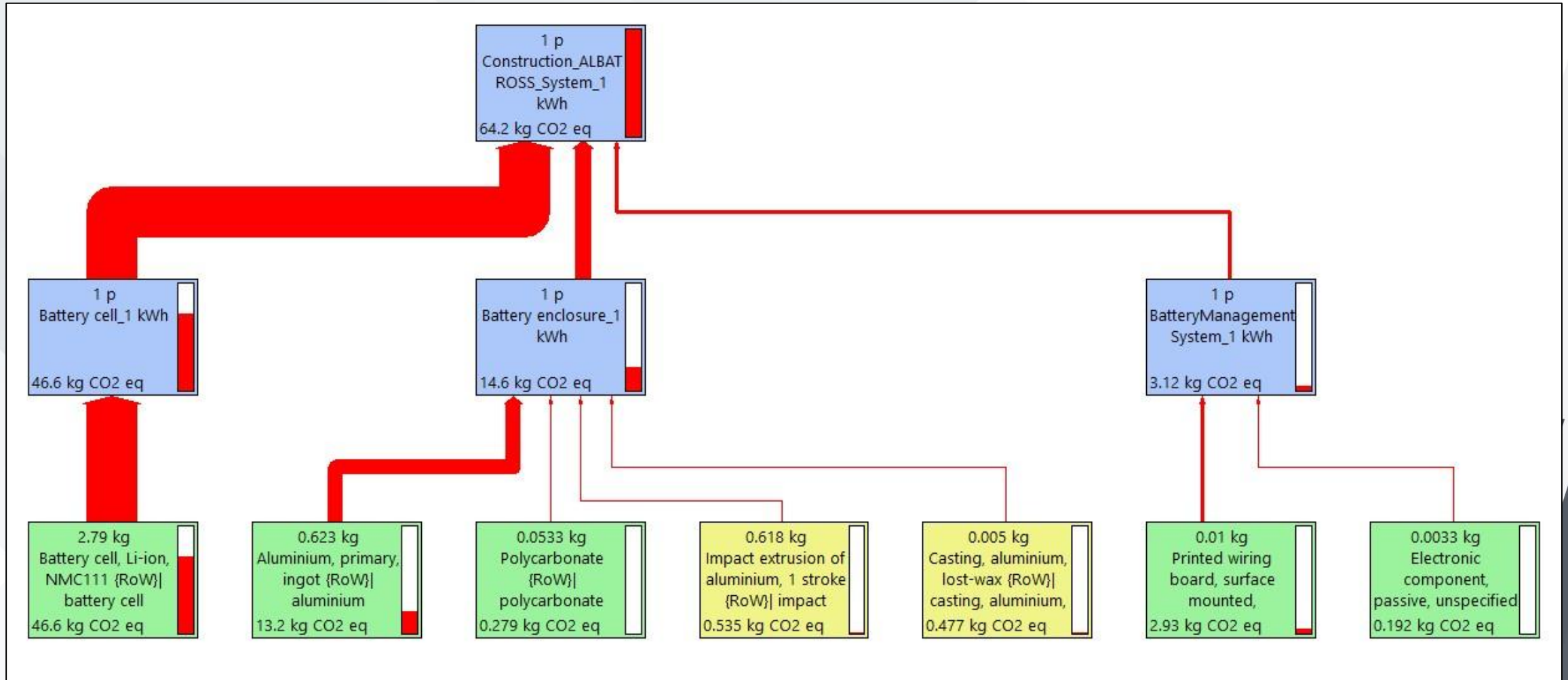

- ❑ The carbon intensity per kWh of EV battery capacity obtained in the range 30 to 400 kg CO₂ eq / kWh from the literature survey (European Commission 2018; IVL 2019).

Contributions of 18 environmental metrics in Battery cell, battery enclosure and management systems

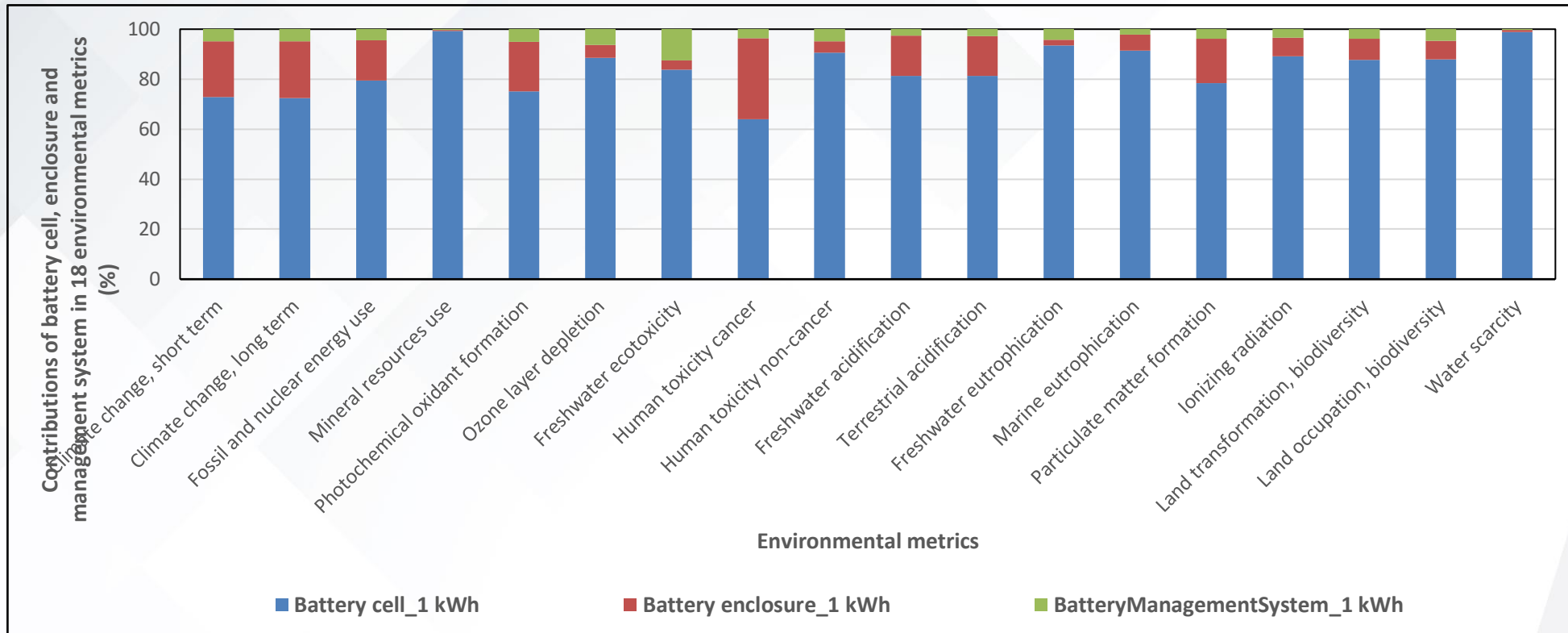



The carbon footprint of ALBATROSS Battery system comprising battery cell, battery enclosure and management systems

Functional unit: 1 kWh of energy delivered

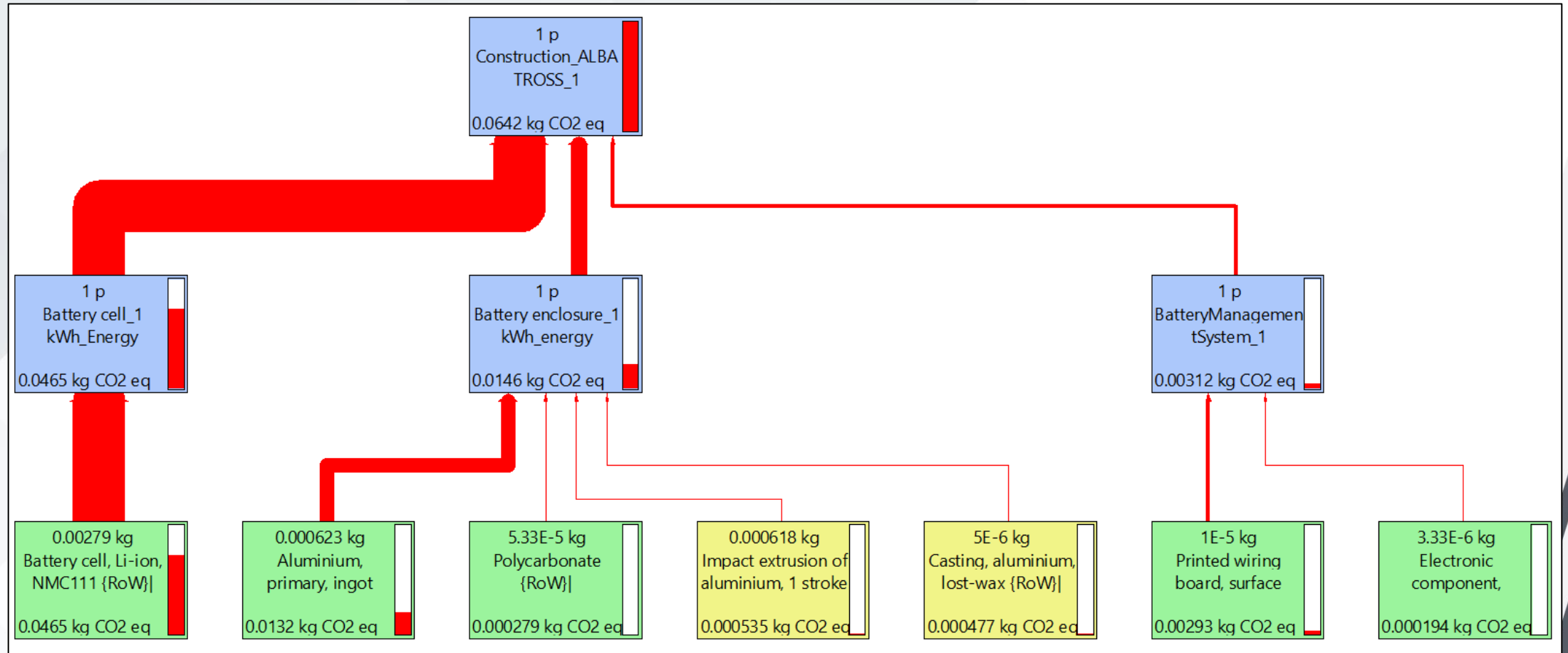

- The carbon intensity per kWh energy delivered range from 0.1 to 0.5 kg CO₂eq / kWh from the secondary sources (Baumann et al (2017)).

The carbon footprint of ALBATROSS Battery system comprising battery cell, battery enclosure and management systems

Functional unit: 1 km of travelled

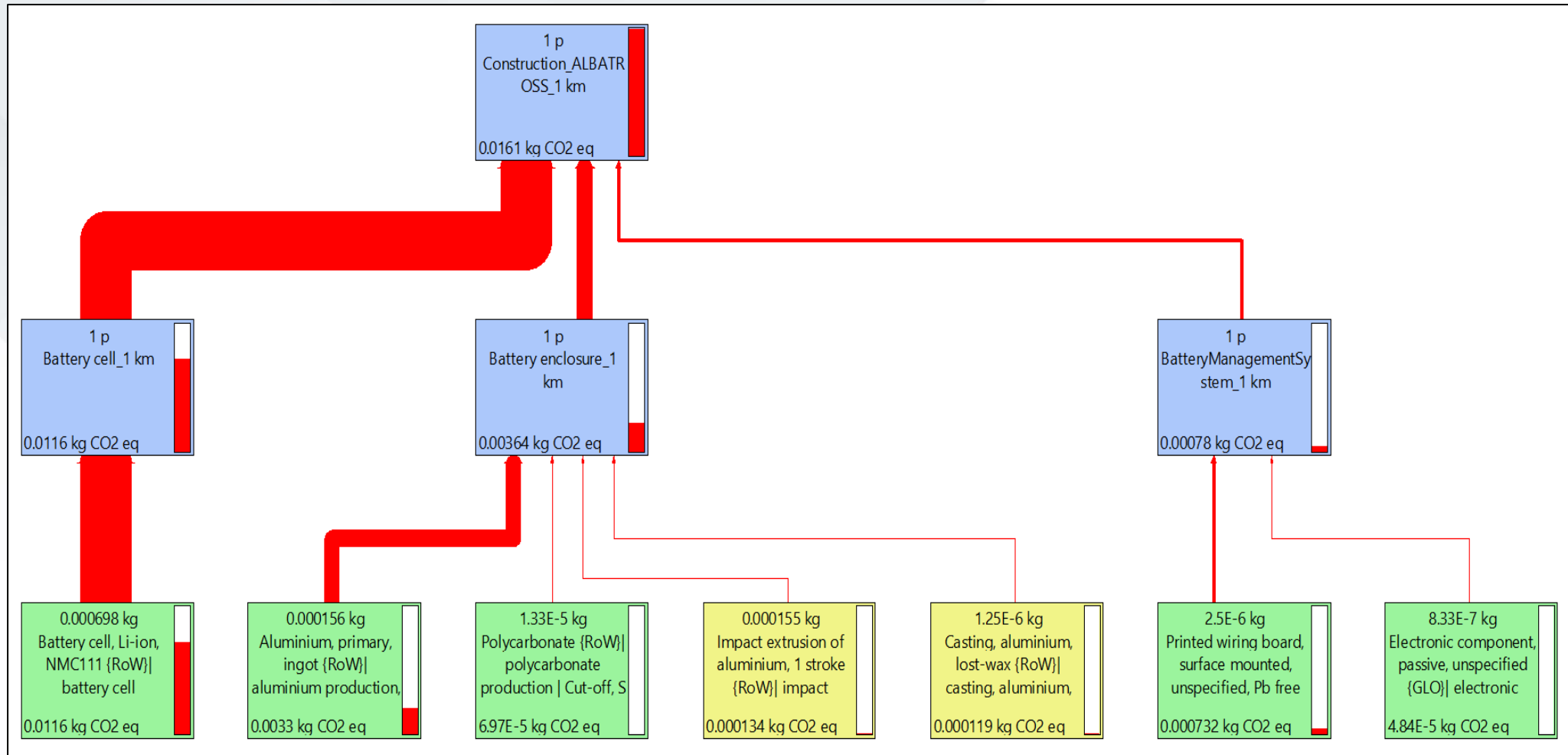

- The carbon intensity per km is in the range from 9.5 to 59.6 g CO₂eq / km from the secondary sources (Energies **2020**, 13, 2864; doi:10.3390/en13112864)).



THANKS!



SUMMARY

During the webinar, the participants discussed various aspects of lifecycle assessment (LCA) and its integration with eco-design and circular economy principles in the context of electric vehicle (EV) battery projects. The meeting covered four main projects: Liberty, Marble, Helios, and Albatross.

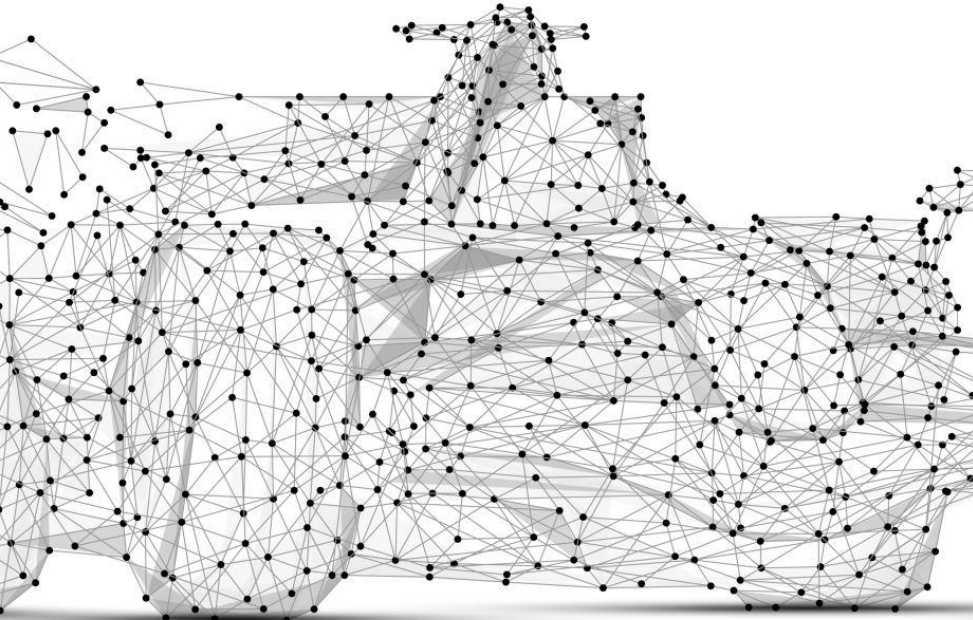
- q Aitor P from the Liberty project shared insights on the importance of considering second life and recycling in LCA. The project aims to design a novel EV battery with improved sustainability, targeting at least a 20% reduction in environmental impact compared to a benchmark battery. The project also explores the impact of second life scenarios on sustainability metrics, such as global warming potential (GWP) and abiotic depletion potential (ADP), and the importance of considering logistics in regulations.
 - q Violeta V from the Marble project discussed the integration of eco-design and LCA to identify environmental hotspots and develop strategies to reduce the environmental impact of battery packs. The project uses a four-step methodology to identify hotspots, develop strategies, adapt them to technical requirements, and design specific actions. The LCA considers the entire life cycle of the battery, including second life and end-of-life scenarios, with functional units based on kilometers traveled and kilowatt-hours of energy provided.
 - q Victor F from the Helios project presented on the role of recycling in LCA and its impact on the battery industry. The project focuses on developing a new hydrometallurgical process for recycling batteries and integrating LCA to assess the environmental impact of these processes. The LCA model includes considerations for the circular economy and aligns with new battery regulations.
 - q Hye from the Albatross project shared the approach to conducting cradle-to-grave LCA for an advanced lightweight battery system. The project aims to reduce weight, charging time, and increase driving range and peak energy density. The LCA covers the construction phase, use phase, and end-of-life, with functional units reflecting energy delivered and kilometers traveled.
 - q Throughout the meeting, the participants discussed the challenges of incorporating circular economy indicators into LCA impact categories, the importance of iterative LCA processes in technology development, and the difficulties in addressing critical raw material scarcity within LCA models. They also debated the most appropriate functional unit for LCA in battery projects, considering the goals of the study and the context of the electric vehicle.
- 

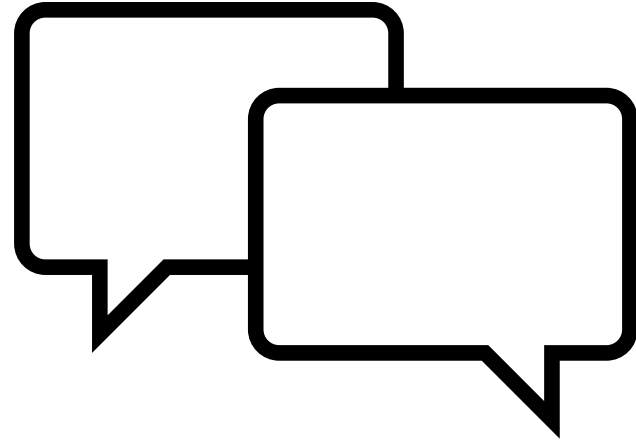
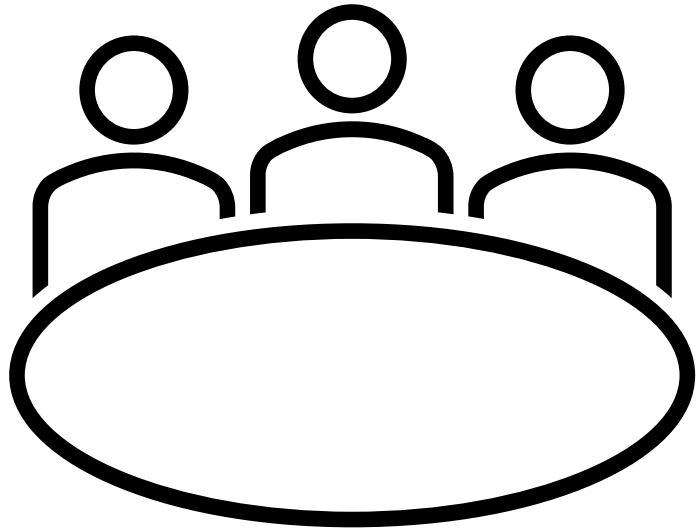

PANEL DISCUSSION: "Common points between the different projects and lessons learned"



Q&A

1. Aitor from the Liberty Project discussed the impact of new EU regulations on electric vehicle batteries and the project's aim to design a battery with improved sustainability. He presented a lifecycle management study comparing scenarios with and without a second life for batteries. The study found significant potential for impact reduction through second-life applications, but noted that current circularity metrics may not fully capture these benefits. Future steps include further analysis and alignment with EU regulations.

2. Violeta from the Marble Project emphasized the integration of eco-design and lifecycle assessment (LCA) to identify environmental hotspots and develop impact reduction plans for battery packs. She outlined a four-step methodology used in the project and stressed the importance of iterative LCA application throughout the design process to accommodate evolving technologies and sustainability goals.
3. Victor from the Helios project presented on the role of recycling in LCA and its impact on the battery industry. He discussed the exploration of new recycling processes and the integration of LCA in end-of-life management, highlighting the project's efforts to align with new EU battery regulations and the digital battery passport.
4. Hye from the Albatross project shared insights into the LCA of advanced lightweight battery systems for electric vehicles, focusing on the construction phase and the use of the Impact World+ methodology. The project aims to compile comprehensive data across all lifecycle stages to compare with current state-of-the-art results.
5. The panel discussed the importance of including circular economy indicators in LCA impact categories, with Aitor suggesting that while LCA provides robust data, circularity metrics are also crucial for managing sustainability effectively.
6. Violeta and Victor discussed the challenges of incorporating critical raw material scarcity into LCA models, noting that while current methodologies like abiotic depletion do not fully address criticality, there are other indexes and approaches that can complement LCA.
7. The panel debated the appropriate functional unit for LCA in battery projects, with Violeta advocating for a unit that reflects the battery's efficiency and its context within an electric vehicle, while Victor proposed considering the "throw out" energy to account for battery efficiency.

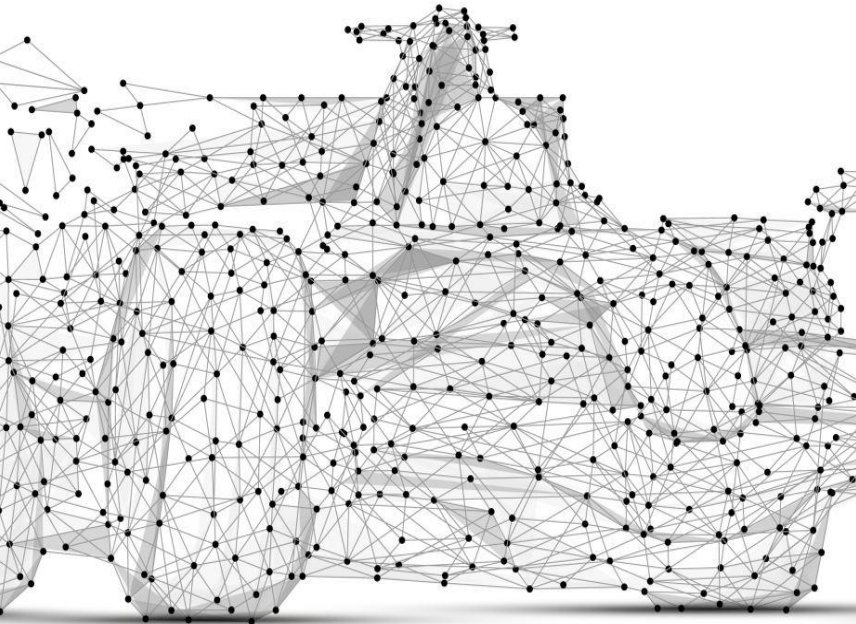



Wra-up

Throughout the meeting, the participants discussed the challenges of incorporating circular economy indicators into LCA impact categories, the importance of iterative LCA processes in technology development, and the difficulties in addressing critical raw material scarcity within LCA models. They also debated the most appropriate functional unit for LCA in battery projects, considering the goals of the study and the context of the electric vehicle.

The discussions indicated ongoing work and future analyses to align with EU regulations, improve sustainability, and refine LCA methodologies within each project.

The background of the image shows three brushes with dark bristles and light-colored handles, arranged diagonally on a wooden surface. The image is overlaid with a semi-transparent green filter. A thin white horizontal line is positioned below the text.

Thank you very much